



***Procedure for checking
over-voltage damage.***

Published september 16, 2015

Contents

Checking procedure for over-voltage damage	6
1. Check Schottky diode measurement with multimeter in diode mode;.....	6
2. Check voltage drop between diode array pin#1 and Ground.....	7
3. Check termination resistors resistance in RJ-45 connector.....	8
RB2011 series RouterBoards	9
List of RB2011 series RouterBoards:.....	9
Disassembling information.....	10
Schottky diode measuring with multimeter in diode mode.....	12
Voltage drop between diode array pin#1 and Ground.....	12
Termination resistors resistance in RJ-45 connector.....	13
CCR1009 series RouterBoards	14
List of CCR1009 series RouterBoards:.....	14
Disassembling information.....	15
Schottky diode measuring with multimeter in diode mode.....	18
Voltage drop between diode array pin#1 and Ground.....	18
Termination resistors resistance in RJ-45 connector.....	19
Cloud Core Router CCR1016-12G, CCR1036-12G series	21
List of Cloud Core Router CCR1016-12G, CCR1036-12G series:.....	21
Disassembling information.....	22
Voltage drop between diode array pin#1 and Ground.....	23
Termination resistors resistance in RJ-45 connector.....	24
Cloud Core Router CCR1036-8G-2S+ series	25
List of Cloud Core Router CCR1036-8G-2S+ series:.....	25
Disassembling information.....	26
Voltage drop between diode array pin#1 and Ground.....	28
Termination resistors resistance in RJ-45 connector.....	29
RB750r2 series RouterBoards	30
List of RB750r2 series:.....	30
Disassembling information.....	32
Schottky diode measuring with multimeter in diode mode.....	34
Voltage drop between diode array pin#1 and Ground.....	34
75R termination resistors resistance.....	35
RB922GS-5HPac series RouterBoards	36
RB922GS-5HPac series:.....	36
Disassembling information.....	40
Schottky diode measuring with multimeter in diode mode.....	44
Voltage drop between diode array pin#1 and Ground.....	45
RB921UAGS-5SHPac series RouterBoards	46
RB921GS-5HPac series:.....	46
Disassembling information.....	47
Schottky diode measuring with multimeter in diode mode.....	50

Voltage drop between diode array pin#1 and Ground.....	51
RBmAP series RouterBoards.....	52
RBmAP series:.....	52
Disassembling information.....	53
Schottky diode measuring with multimeter in diode mode.....	55
Voltage drop between diode array pin#1 and Ground.....	56
RBcAP series RouterBoards.....	57
RBcAP series:.....	57
Disassembling information.....	58
Schottky diode measuring with multimeter in diode mode.....	59
Voltage drop between diode array pin#1 and Ground.....	60
75R Termination resistors resistance.....	61
RBDynaDish series RouterBoards.....	62
RBDynaDish series:.....	62
Disassembling information.....	63
Schottky diode measuring with multimeter in diode mode.....	64
.....	64
Voltage drop between diode array pin#1 and Ground.....	65
RB953GS-5HnT series RouterBoards.....	66
Schottky diode measuring with multimeter in diode mode.....	67
.....	67
Voltage drop between diode array pin#1 and Ground.....	68
75R Termination resistors resistance.....	69
RB850Gx2 series RouterBoards.....	71
Schottky diode measuring with multimeter in diode mode.....	72
Voltage drop between diode array pin#1 and Ground.....	73
75R Termination resistors resistance.....	74
RB912G - 2HnD series RouterBoards.....	76
BaseBox 2 disassembling information.....	79
Schottky diode measuring with multimeter in diode mode.....	81
Voltage drop between diode array pin#1 and Ground.....	82
75R Termination resistors resistance.....	83
RB912G - 5HPnD series RouterBoards.....	84
QRT 5 disassembling information.....	88
Schottky diode measuring with multimeter in diode mode.....	92
Voltage drop between diode array pin#1 and Ground.....	93
75R Termination resistors resistance.....	94
RBSXTG-5HPacD series RouterBoards.....	95
RBSXTG-5HPacD series:.....	95
Disassembling information.....	96
Schottky diode measuring with multimeter in diode mode.....	98
Voltage drop between diode array pin#1 and Ground.....	99
RBSXTLite2 series RouterBoards.....	100

RBSXTLite2 series:.....	100
Disassembling information.....	101
Schottky diode measuring with multimeter in diode mode.....	103
Voltage drop between diode array pin#1 and Ground.....	104
75R Termination resistors resistance.....	105
RBSXTLite5 series RouterBoards.....	106
RBSXTLite5 series:.....	106
Disassembling information.....	107
Schottky diode measuring with multimeter in diode mode.....	109
Voltage drop between diode array pin#1 and Ground.....	110
75R Termination resistors resistance.....	111
RBSXTG-5HPnD series RouterBoards.....	112
RBSXTG-5HPnD series:.....	112
Disassembling information.....	113
Schottky diode measuring with multimeter in diode mode.....	115
Voltage drop between diode array pin#1 and Ground.....	116
75R Termination resistors resistance.....	117
hAP lite series RouterBoards.....	118
1.Disassembling information.....	119
Voltage drop between Ethernet signal lines and Ground.....	122
RB951G-2HnD series RouterBoards.....	123
Disassembling information.....	124
Schottky diode measuring with multimeter in diode mode.....	125
Voltage drop between diode array pin#1 and Ground.....	125
75R termination resistors resistance.....	126
RB951Ui-2HnD series RouterBoards.....	127
Disassembling information.....	128
Schottky diode measuring with multimeter in diode mode.....	129
Voltage drop between diode array pin#1 and Ground.....	129
75R termination resistors resistance.....	130
RB751U-2HnD series RouterBoards.....	131
Disassembling information.....	132
Schottky diode measuring with multimeter in diode mode.....	133
Voltage drop between diode array pin#1 and Ground.....	133
75R termination resistors resistance.....	134
RB951-2n series RouterBoards.....	135
Disassembling information.....	136
Schottky diode measuring with multimeter in diode mode.....	137
Voltage drop between diode array pin#1 and Ground.....	137
75R termination resistors resistance.....	138
CRS112-8G-4S series RouterBoards.....	139
Disassembling information.....	139
Schottky diode measuring with multimeter in diode mode.....	141

Voltage drop between diode array pin#1 and Ground.....	141
75R termination resistors resistance.....	142
CRS210-8G-2S+ series RouterBoards.....	144
Disassembling information.....	144
Schottky diode measuring with multimeter in diode mode.....	146
Voltage drop between diode array pin#1 and Ground.....	146
75R termination resistors resistance.....	147
CRS212-1G-10S-1S+ series RouterBoards.....	148
Disassembling information.....	148
Schottky diode measuring with multimeter in diode mode.....	150
Voltage drop between diode array pin#1 and Ground.....	150
75R termination resistors resistance.....	151
CRS109-8G-4S series RouterBoards.....	152
Disassembling information.....	153
Schottky diode measuring with multimeter in diode mode.....	154
Voltage drop between diode array pin#1 and Ground.....	154
75R termination resistors resistance.....	155
CRS226-24G-2S+ series RouterBoards.....	156
Disassembling information.....	157
Schottky diode measuring with multimeter in diode mode.....	158
Voltage drop between diode array pin#1 and Ground.....	158
75R termination resistors resistance.....	160
CRS125-24G-1S series.....	161
List of Cloud Router Switch CRS125-24G-1S series:.....	161
Disassembling information.....	162
Schottky diode measuring with multimeter in diode mode.....	164
Voltage drop between diode array pin#1 and Ground.....	164
Termination resistors resistance in RJ-45 connector.....	165

Checking procedure for over-voltage damage

Over-voltage can be caused by the following reasons: high voltage surge, lightning, electrostatics etc. You can check if routerboard was damaged by over-voltage, by using the following testing method:

1. Check Schottky diode measurement with multimeter in diode mode;

The multimeter usually has a diode test function:

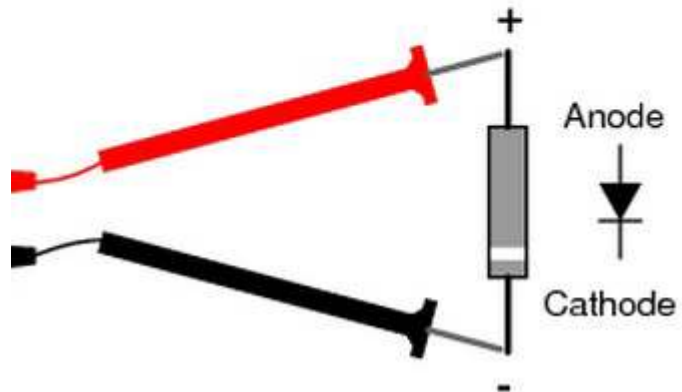

When the test probes are connected as shown the meter gives you the diode voltage drop measurement.

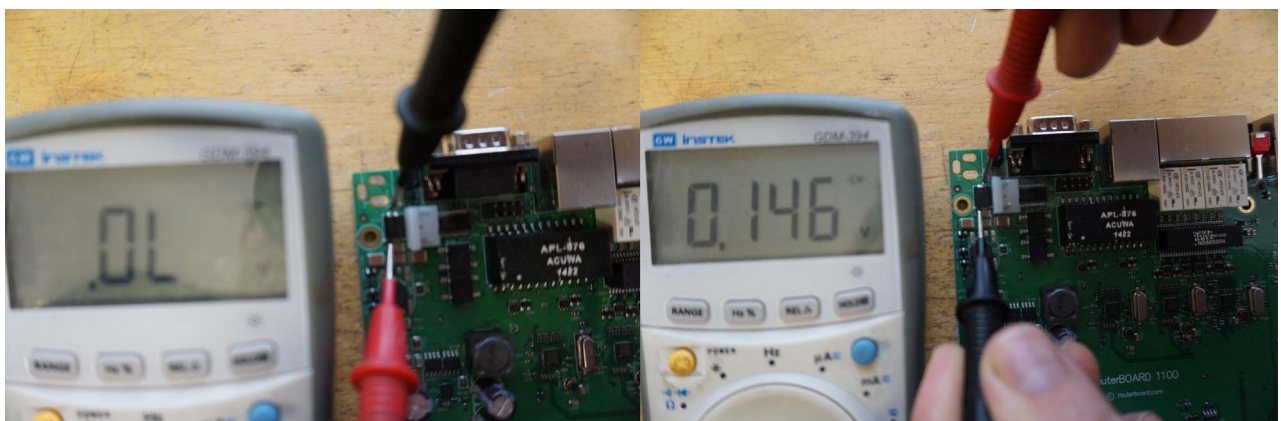

In the same manner we make Diode bridge test, considering schematic of bridge rectifiers

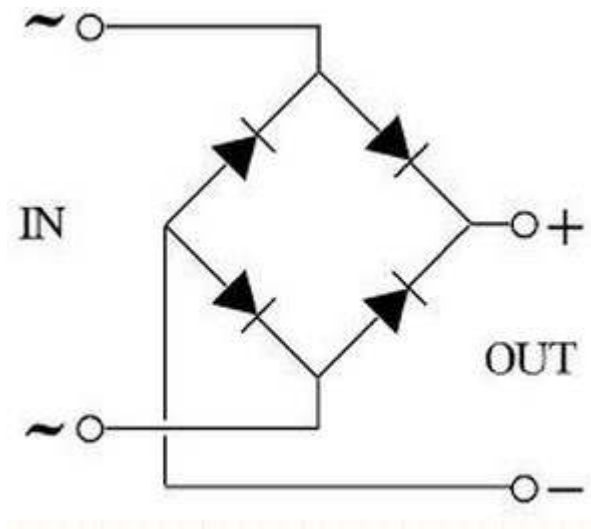

2. Check voltage drop between diode array pin#1 and Ground.

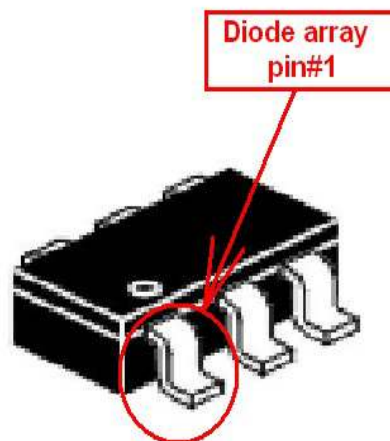

You should measure in diode mode (hold “positive” wire on the Ground and “COM” wire to diode array pin#1). Diode array pin#1 is always marked by dot mark on the diode array case (see picture 1 in the appendix).

Diode array reference number and voltage drop values could be found in the table 1;

3. Check termination resistors resistance in RJ-45 connector.

For this measurement you should take patch cord and plug it into the routerboard (see picture 2 in the appendix), and then measure resistance of termination resistors.



Resistance value between Rx and Tx line must be 150 Ohm $\pm 4\%$.

If resistance value is smaller or higher then Tx/Rx line was damaged by high voltage surge.

RB2011 series RouterBoards

List of RB2011 series RouterBoards:



Disassembling information

Indoor 2011 series RouterBoards

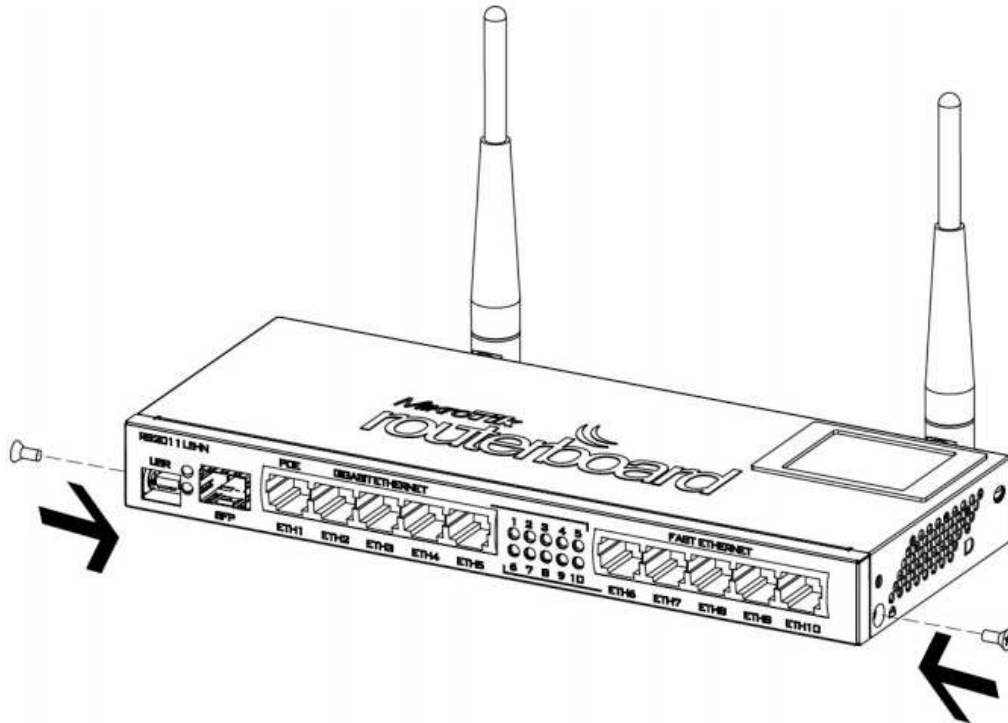

Rackmount 2011 series RouterBoard

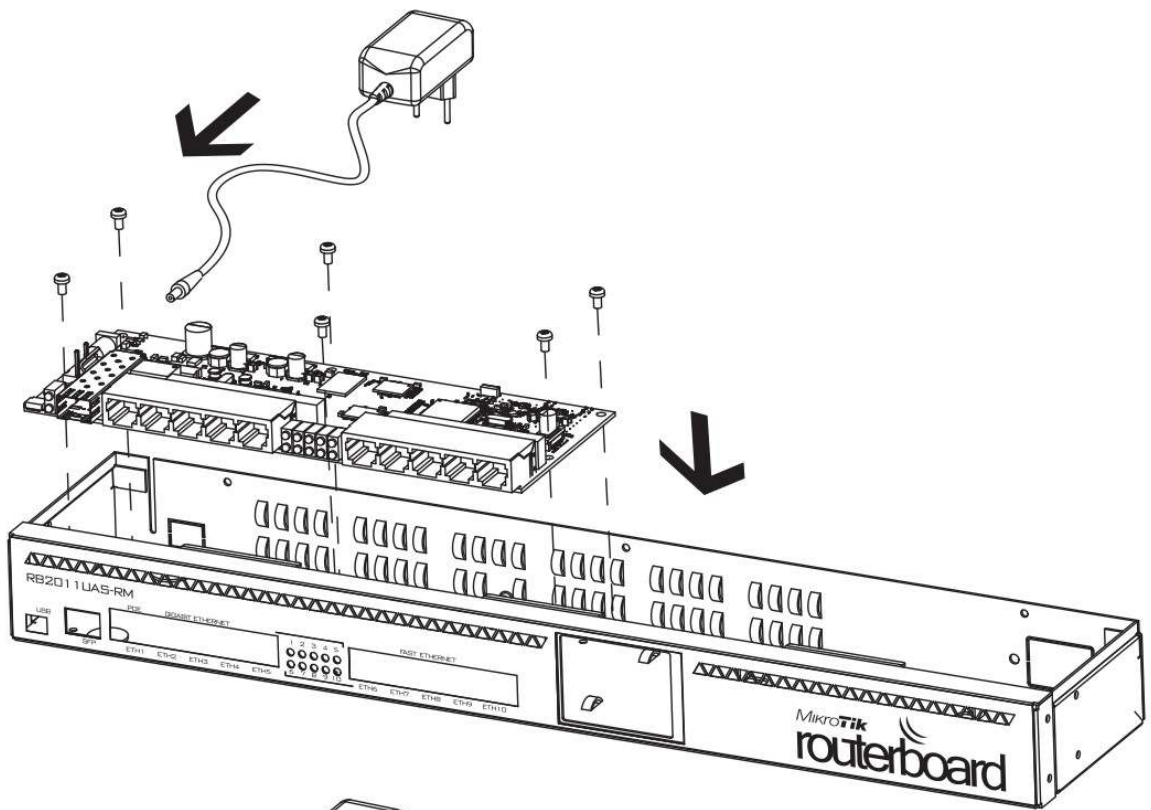
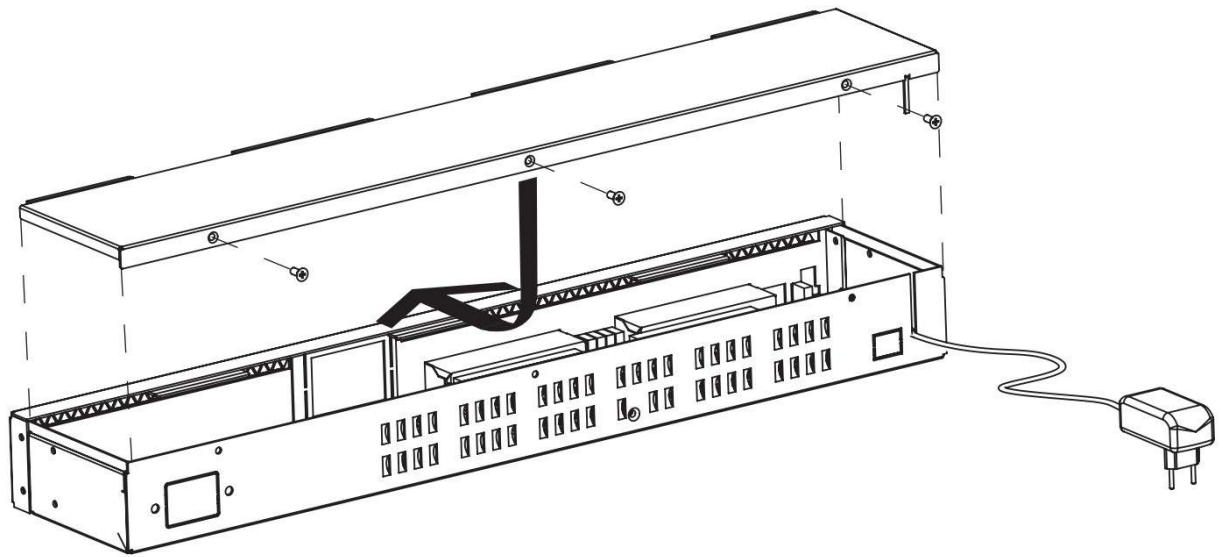

Schottky diode measuring with multimeter in diode mode

Schottky diode reference numbers is D2; Voltage drop value should be about 0,197V
Diode bridges reference numbers are D6, D4. Voltage drop value should be about 0,511V



Voltage drop between diode array pin#1 and Ground.

Check voltage drop between Transformer TR100, TR101 and TR102 pins and Ground.
It should be in the range from 0,32V to 0,438V

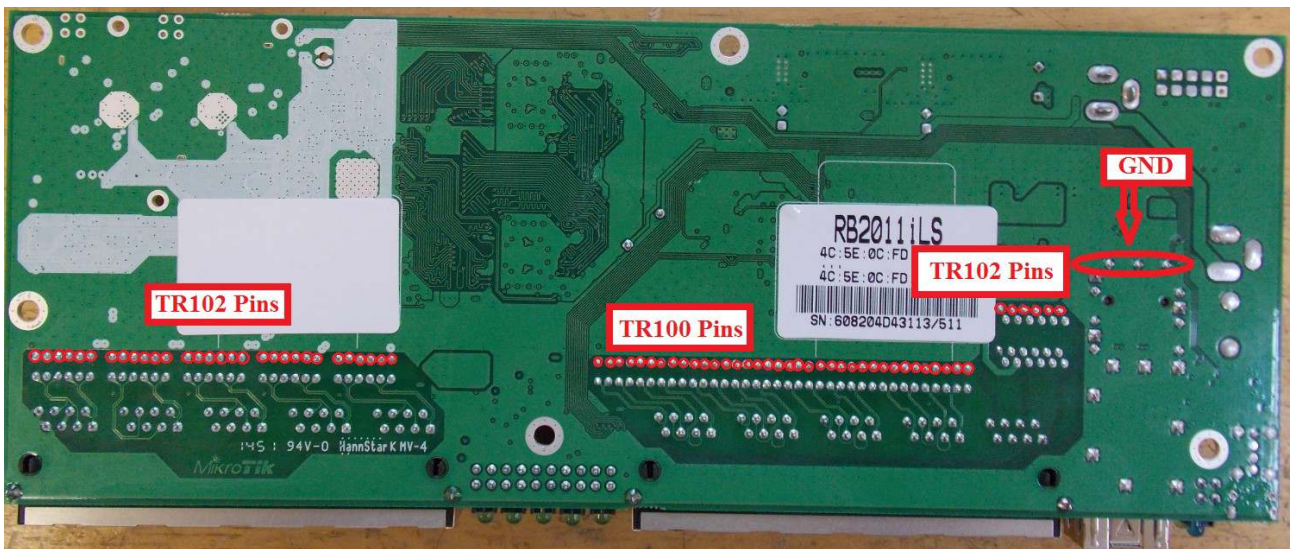

Termination resistors resistance in RJ-45 connector

Red circled resistors resistance should be 75Ohm +/- 1%

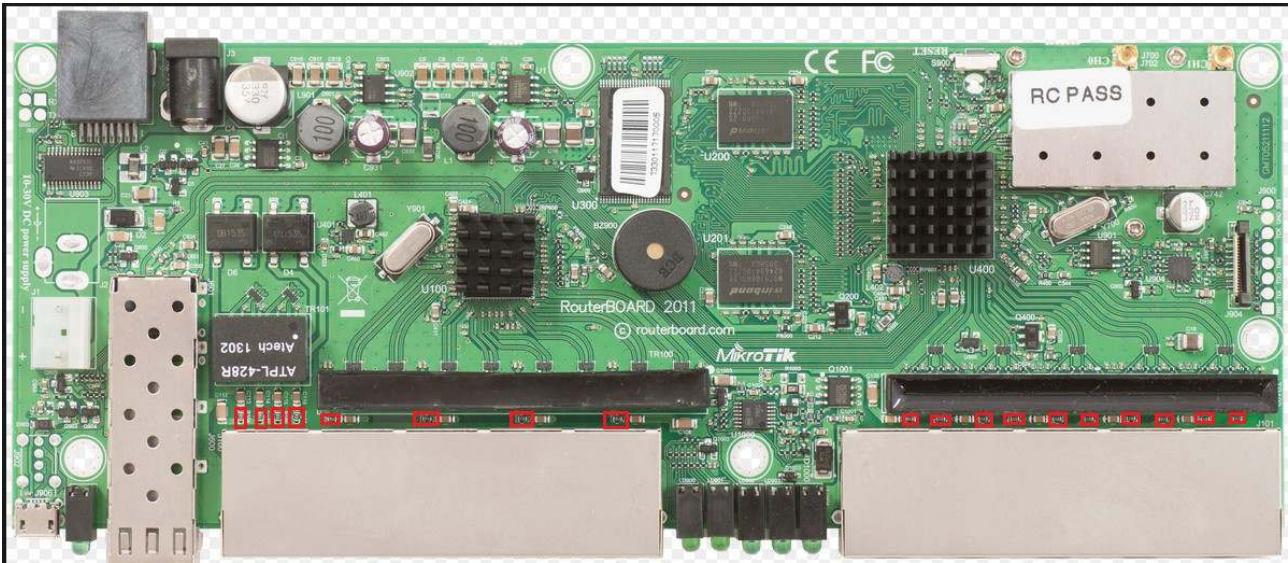

On ports Ether2 – Ether10 You can take patch cord and plug it into the routerboard, and then measure resistance of termination resistors.

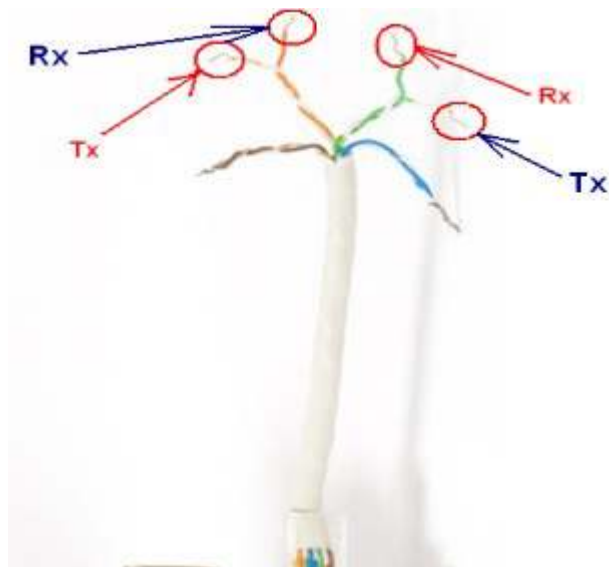

Resistance value between Rx and Tx line must be 150 Ohm +/-4%.

If resistance value is smaller or higher then Tx/Rx line was damaged by high voltage surge.

CCR1009 series RouterBoards

List of CCR1009 series RouterBoards:



CCR1009-8G-1S-1S+PC

Disassembling information

CCR1009-8G-1S-1S+



1. Use PH2 screw driver to loose backside screws then side screws, take off cover. Detach DSUB-9 connector fasteners.



CCR1009-8G-1S-1S+PC

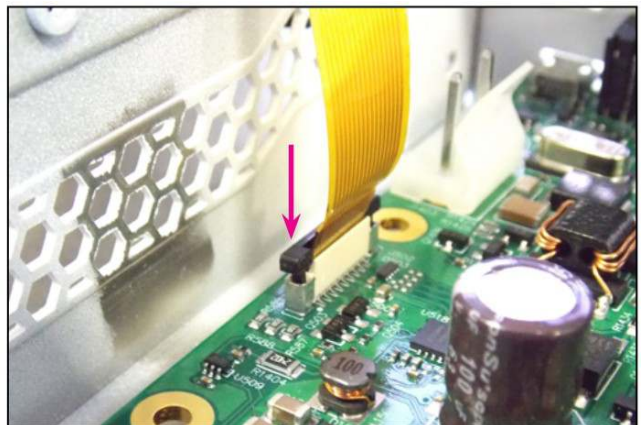
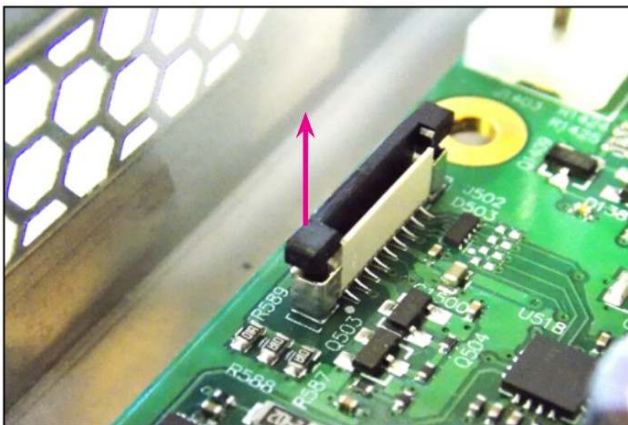
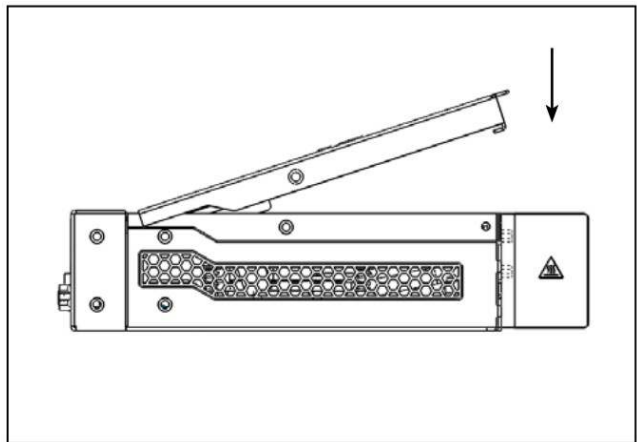
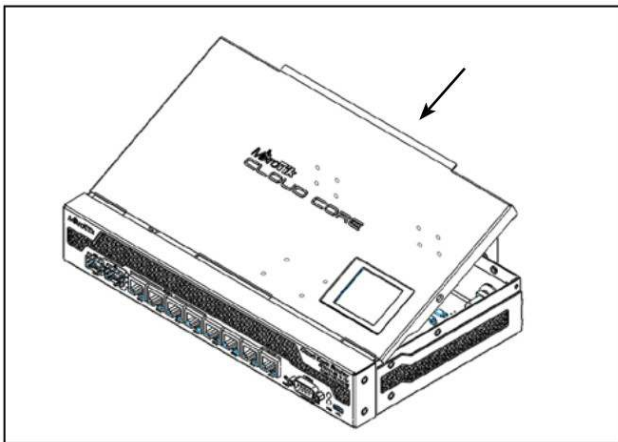
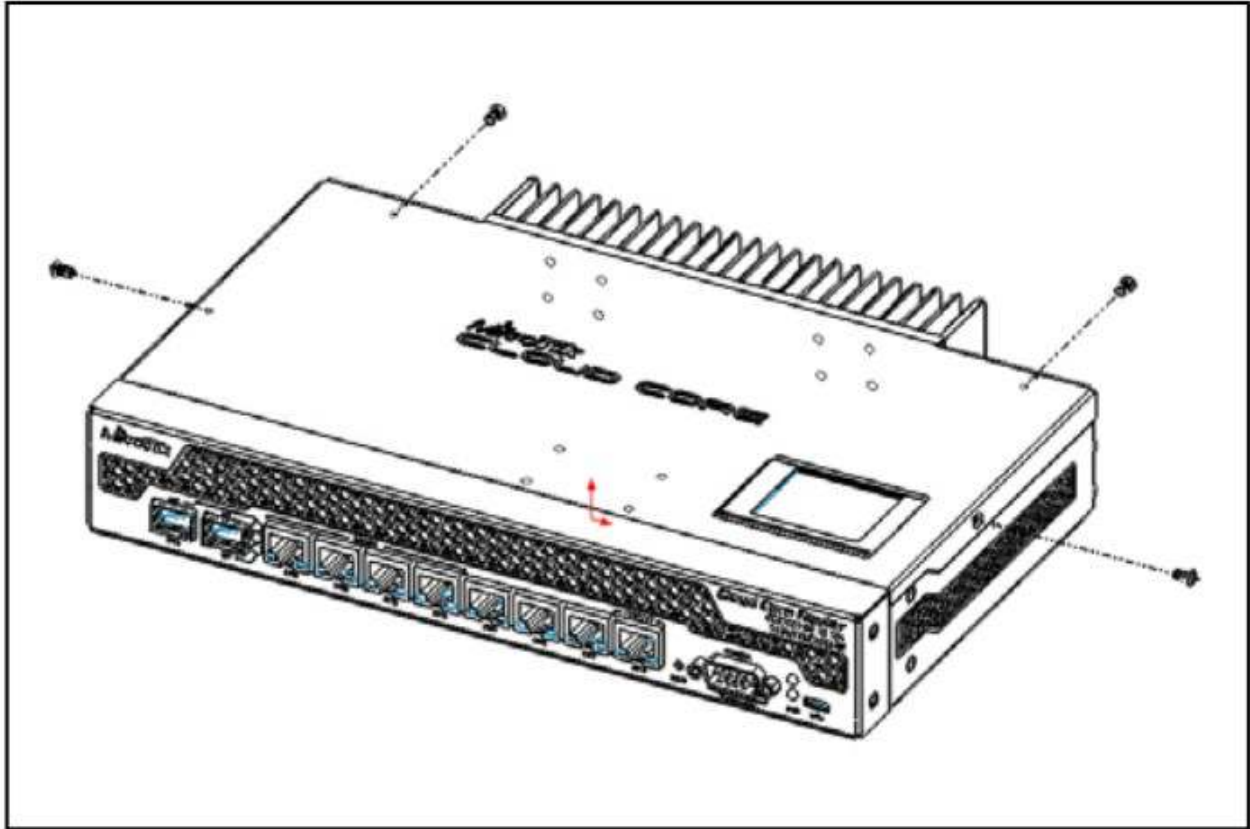

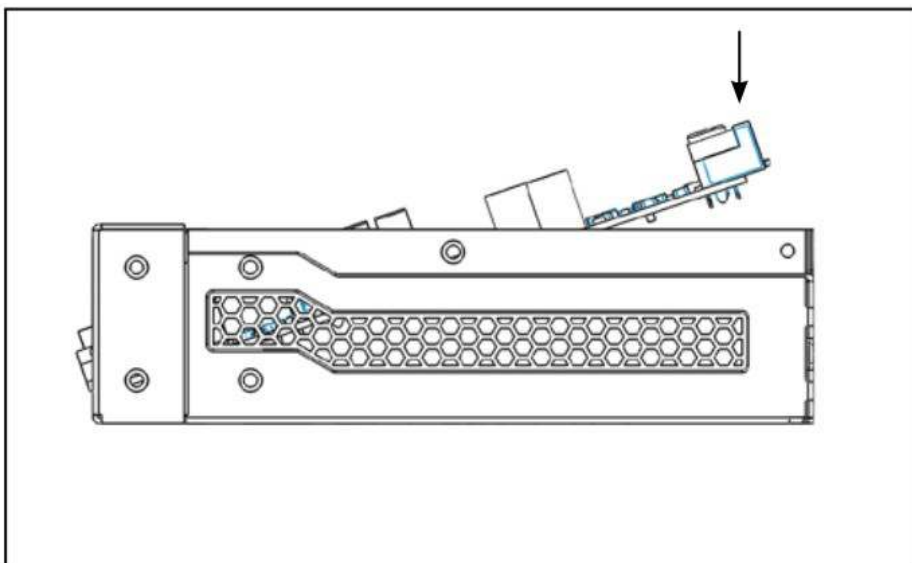
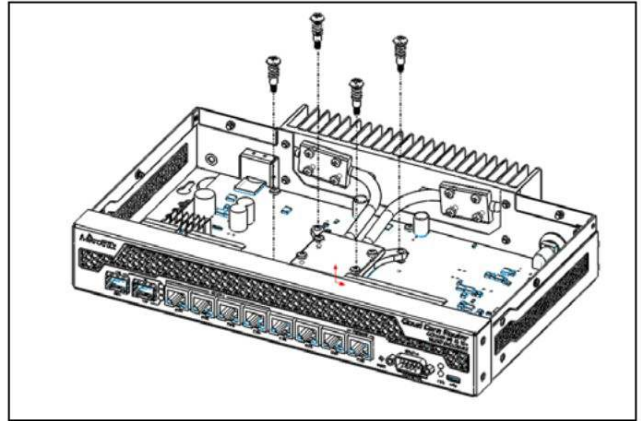
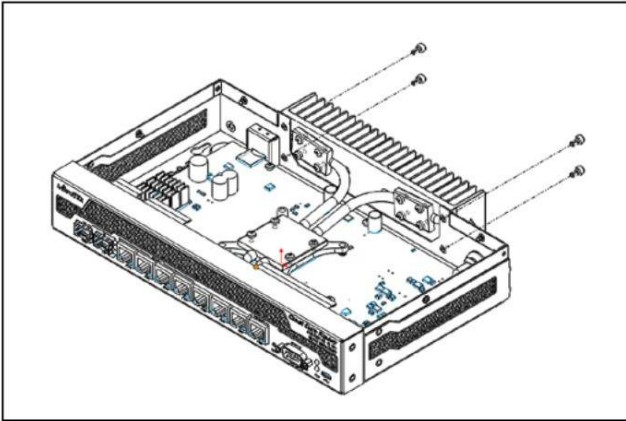
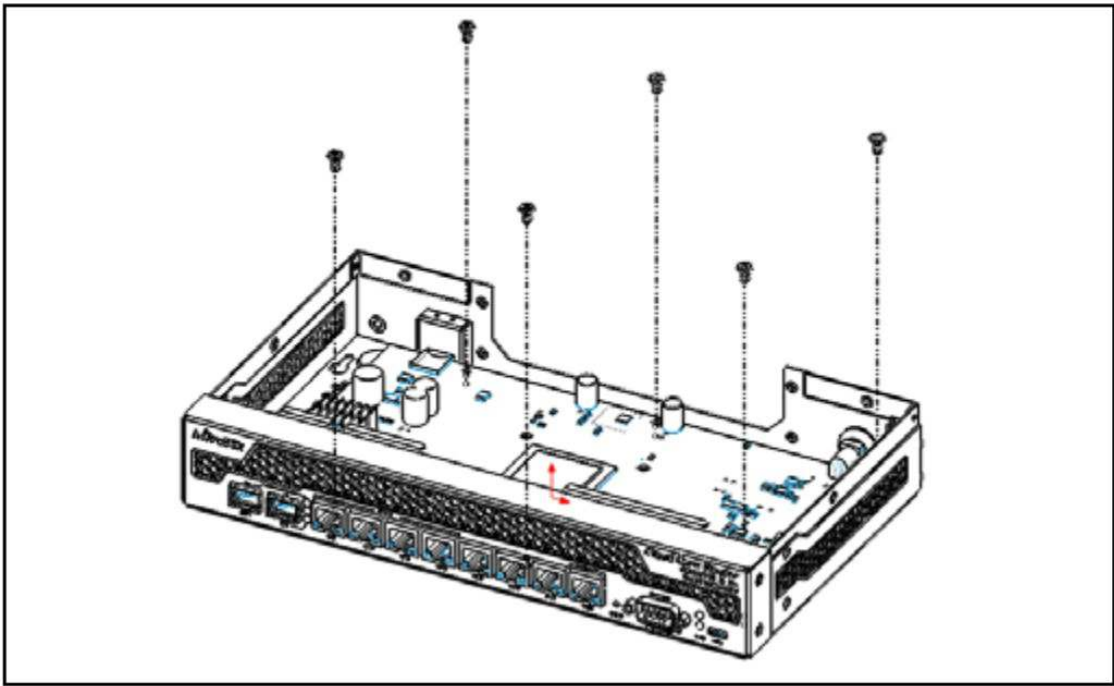

Schottky diode measuring with multimeter in diode mode

Schottky diode reference numbers is D1401, D1402, D1403, D1405. Voltage drop value should be about 0,264V



Voltage drop between diode array pin#1 and Ground.

Check voltage drop between internal Ethernet Transformers on ports Ether2 – Ether8 pins and Ground.

It should be in the range from 0,32V to 0,438V

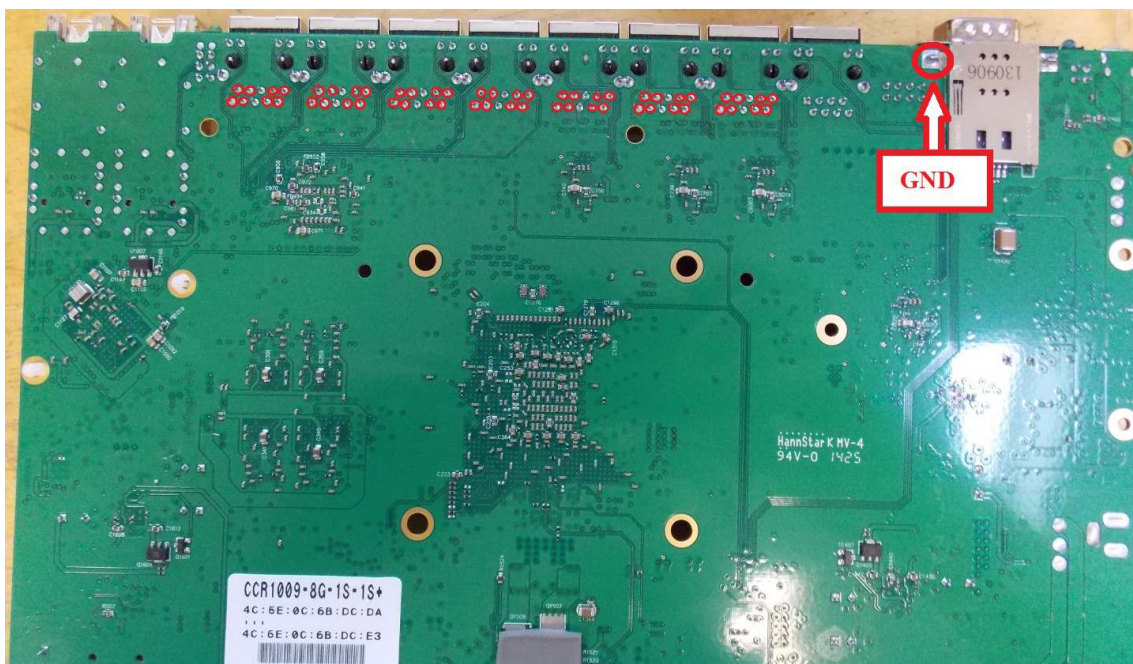

For Ether1 measure voltage drop on TR6 Pins and Ground. It should be in the range from 0,32V to 0,438V

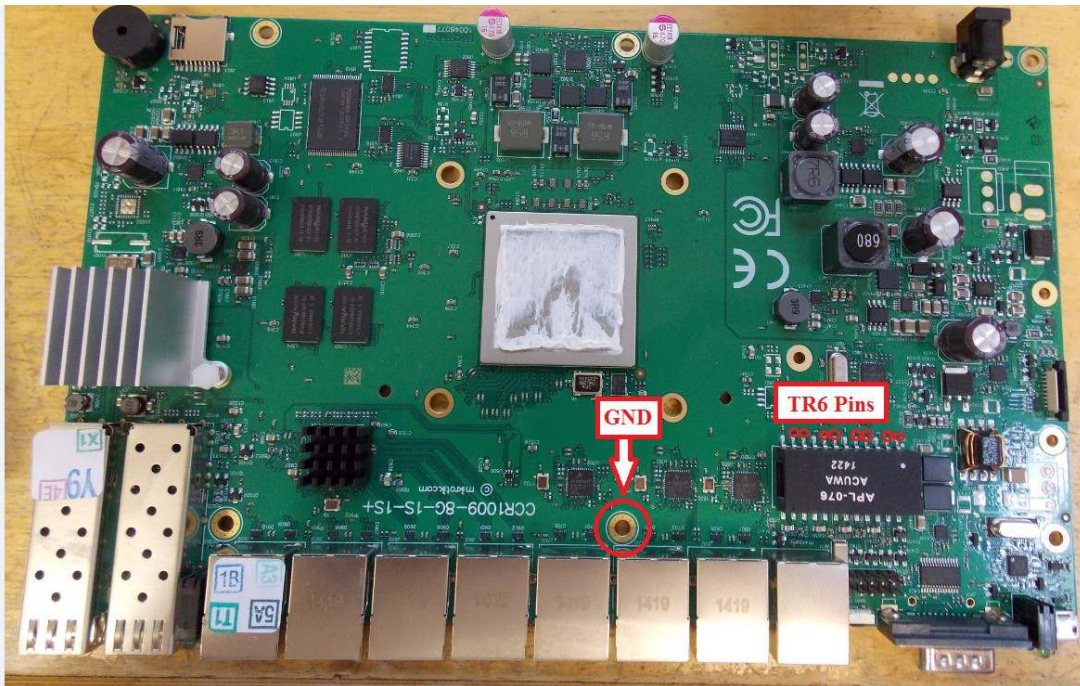

Termination resistors resistance in RJ-45 connector

Red circled resistors resistance should be 75Ohm +/- 1%

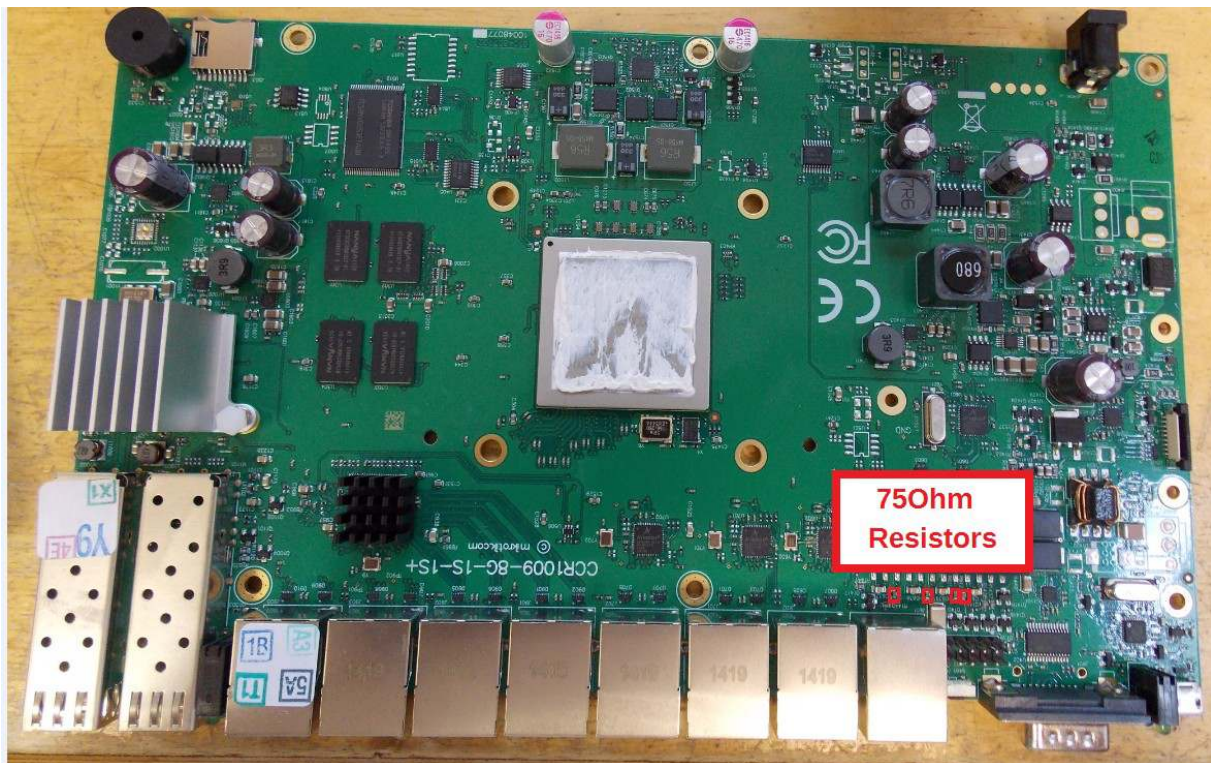

On ports Ether2 – Ether8 You can take patch cord and plug it into the routerboard, and then measure resistance of termination resistors.

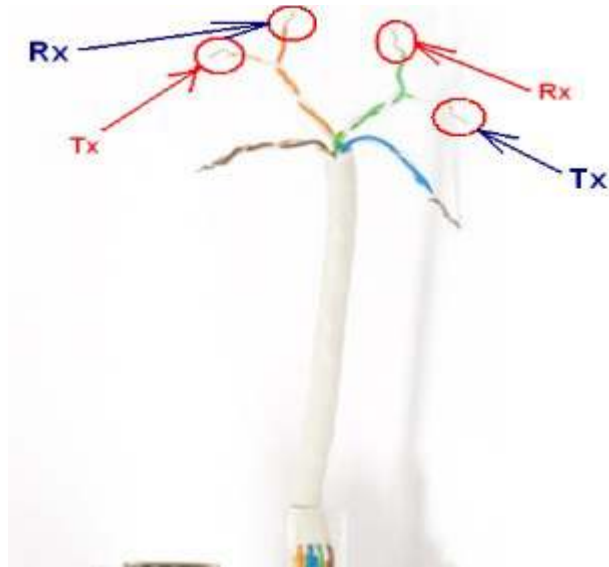

Resistance value between Rx and Tx lines must be 150 Ohm $\pm 4\%$.

If resistance value is smaller or higher then Tx/Rx line was damaged by high voltage surge.

Cloud Core Router CCR1016-12G, CCR1036-12G series

List of Cloud Core Router CCR1016-12G, CCR1036-12G series:

CCR1016-12G



CCR1036-12G-4S

CCR1036-12G-4S-EM



Disassembling information



Voltage drop between diode array pin#1 and Ground.

Check voltage drop between diode arrays pin#1 and Ground. Diode arrays are circled red. It should be in the range from 0,32V to 0,438V

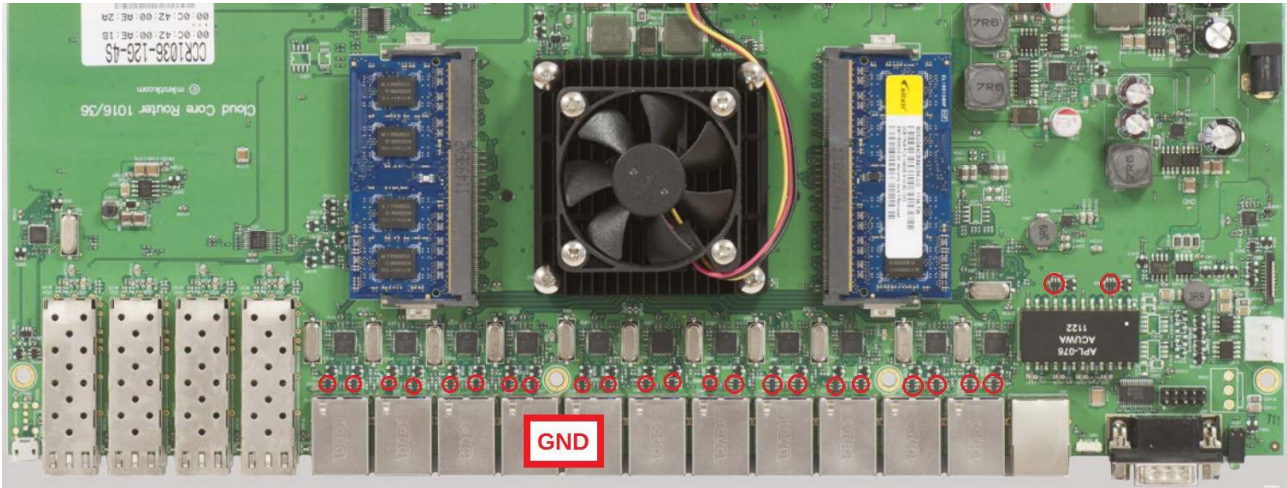

Termination resistors resistance in RJ-45 connector

Red circled resistors resistance should be 75Ohm +/- 1%

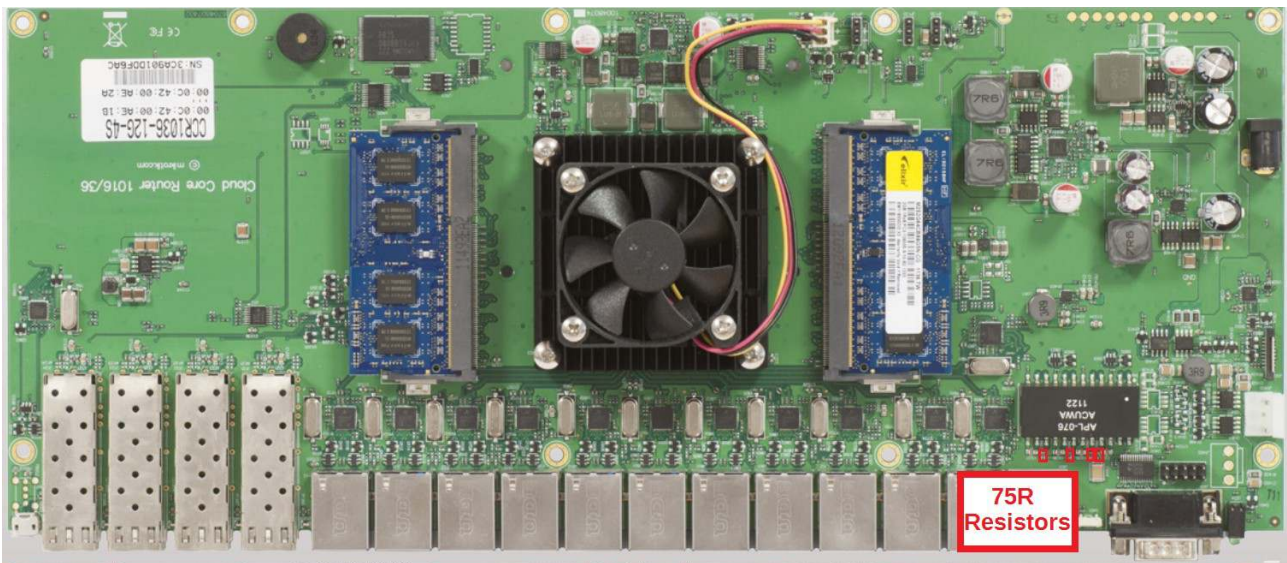

On ports Ether2 – Ether11 You can take patch cord and plug it into the routerboard, and then measure resistance of termination resistors.

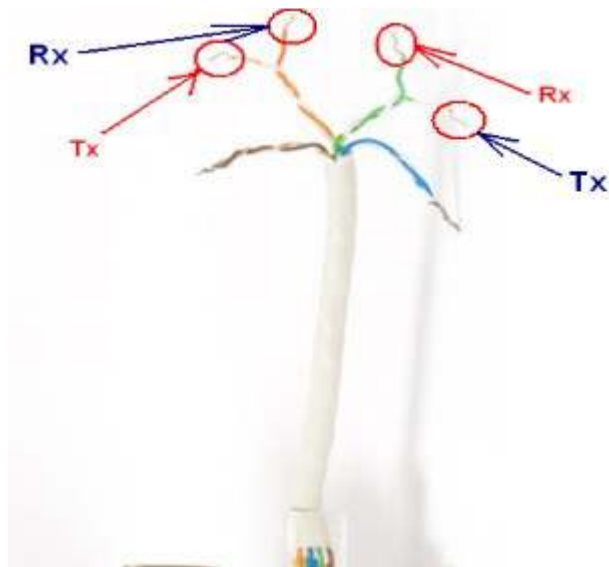

Resistance value between Rx and Tx lines must be 150 Ohm +/-4%.

If resistance value is smaller or higher then Tx/Rx line was damaged by high voltage surge.

Cloud Core Router CCR1036-8G-2S+ series

List of Cloud Core Router CCR1036-8G-2S+ series:

CCR1036-8G-2S+

CCR1036-8G-2S+EM



Disassembling information



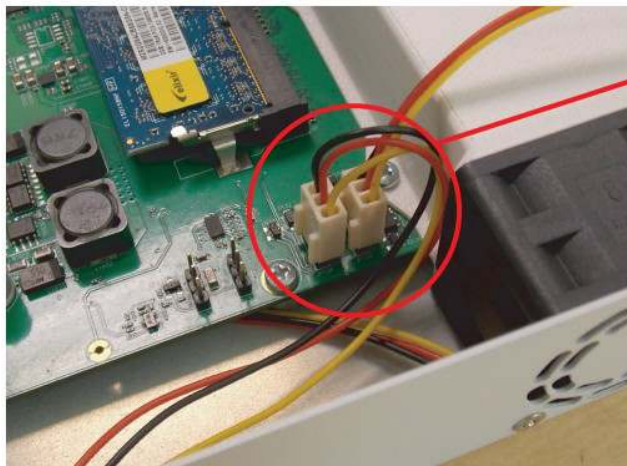
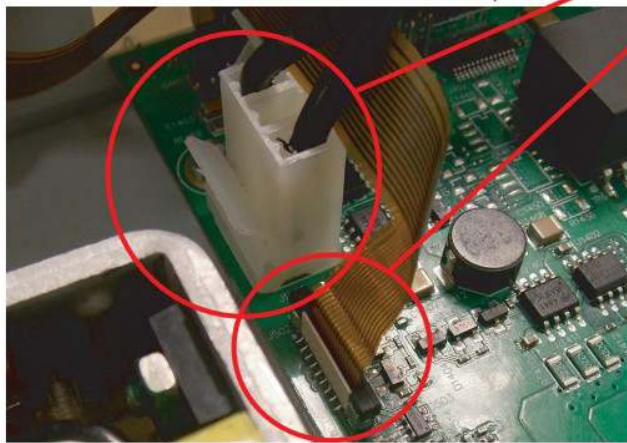
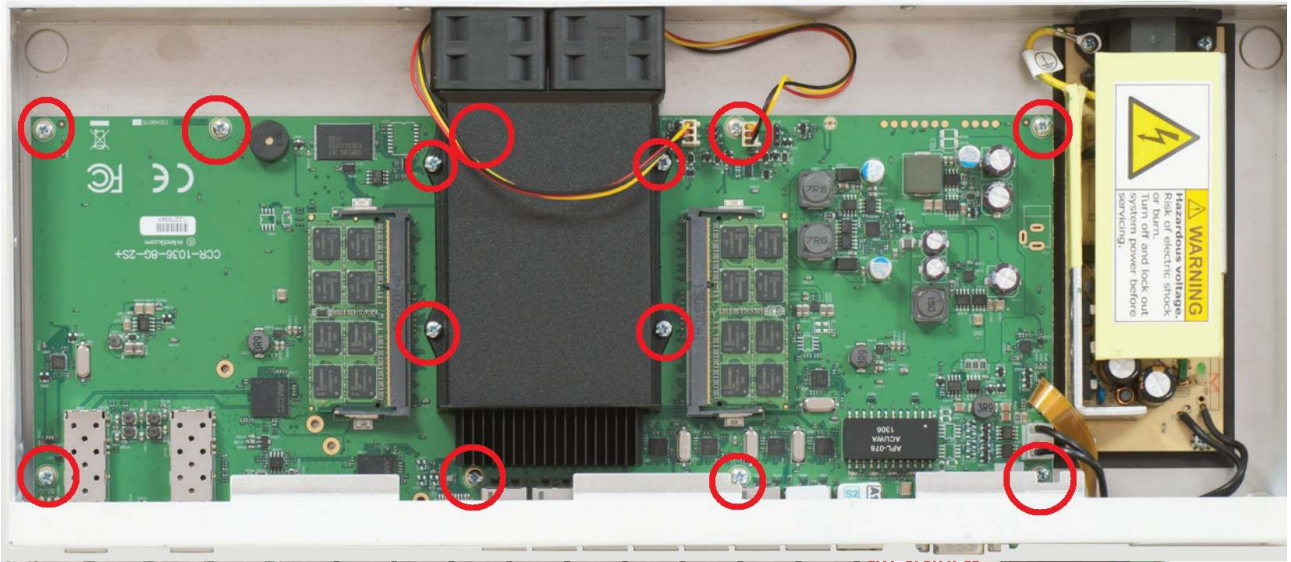

Voltage drop between diode array pin#1 and Ground.

Check voltage drop between internal Ethernet Transformers on ports Ether1 – Ether7 pins and Ground. Ether Pins are circled red.

It should be in the range from 0,32V to 0,438V



Termination resistors resistance in RJ-45 connector

Red circled resistors resistance should be 75Ohm +/- 1%

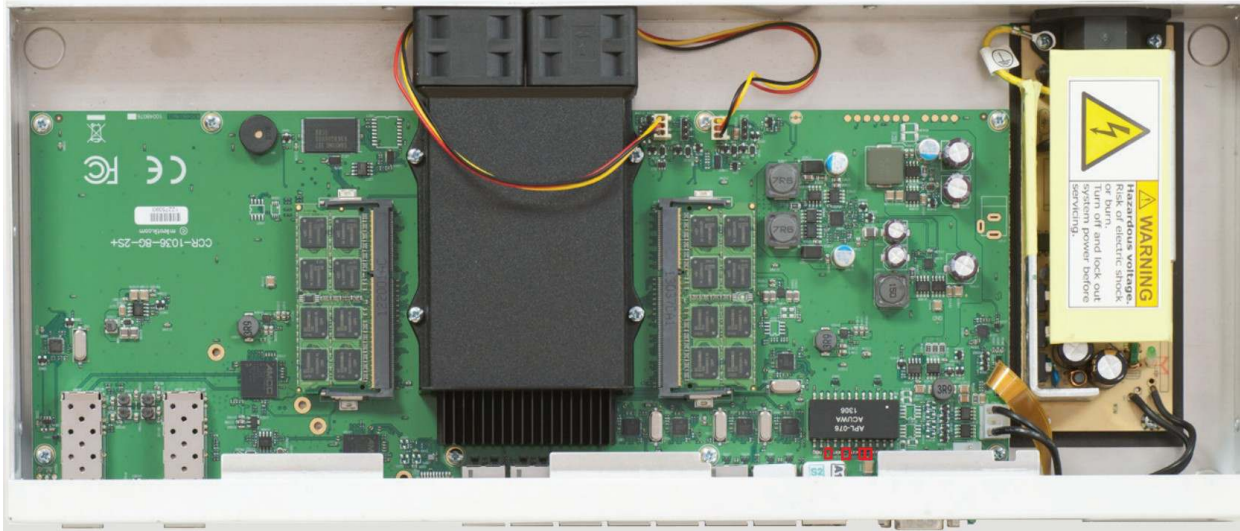

On ports Ether1 – Ether7 You can take patch cord and plug it into the routerboard, and then measure resistance of termination resistors.

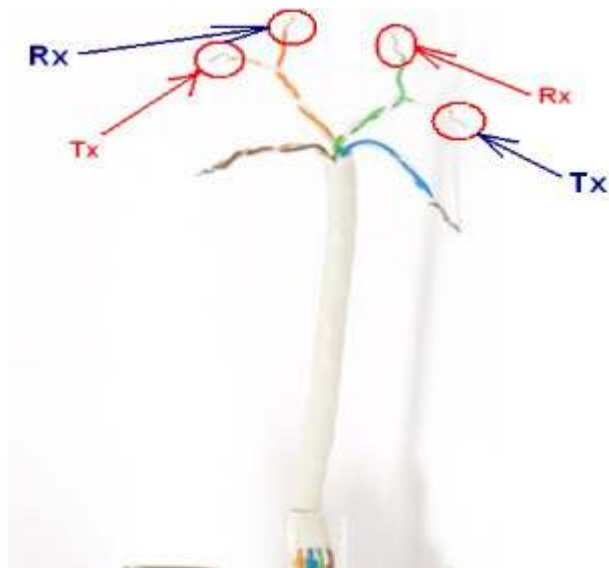

Resistance value between Rx and Tx lines must be 150 Ohm +/-4%.

If resistance value is smaller or higher then Tx/Rx line was damaged by high voltage surge.

RB750r2 series RouterBoards

List of RB750r2 series:

PowerBox



hEX lite



hEX PoE lite



Disassembling information

PowerBox disassembling

1. step

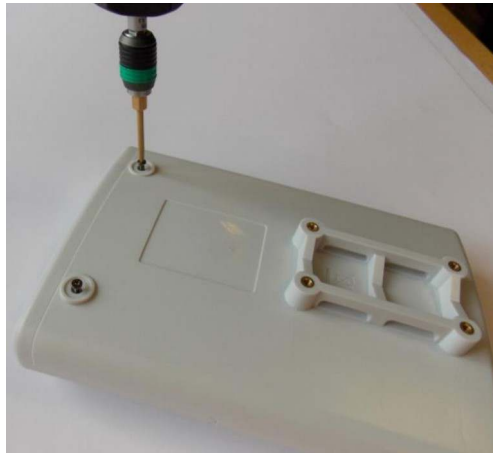

Unscrew with Torx T8

2. step

Remove board from case



3. Step

Incline fixed plastic clips to sever board from case.

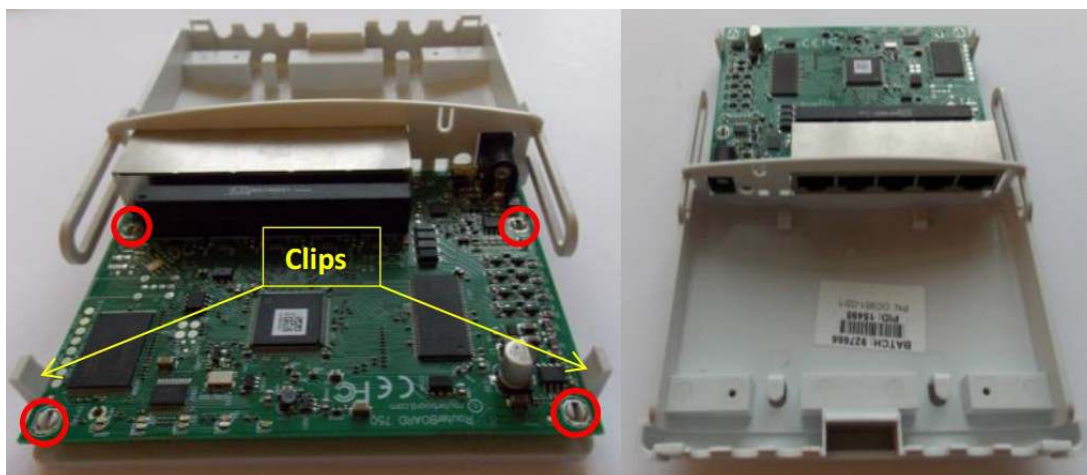

hEX lite and hEX PoE lite disassembling

Take off the cover with a screwdriver as shown in the picture1



Picture1

Take out the board with a screwdriver as shown in the picture2

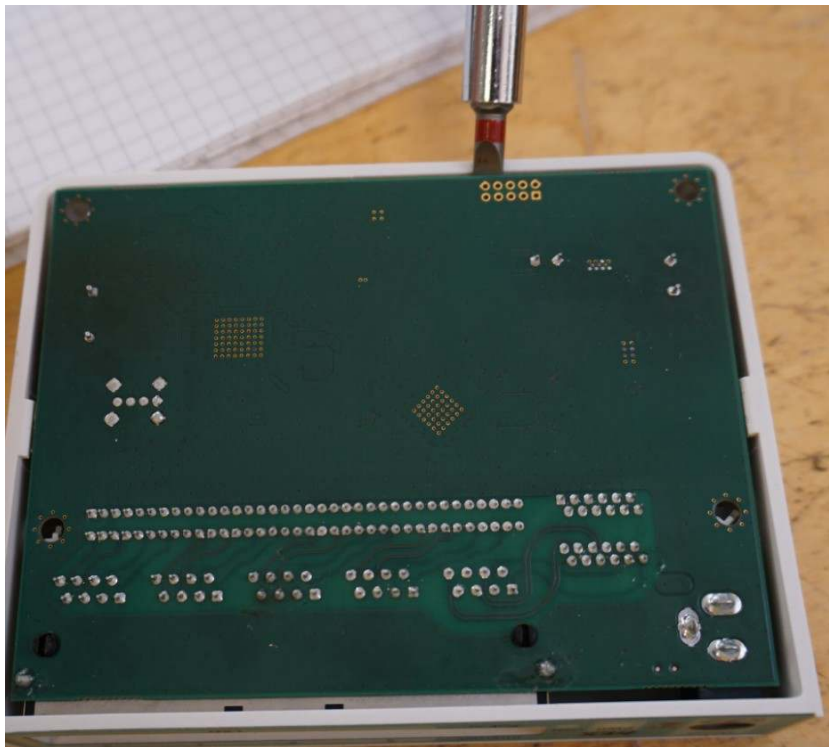

Picture1

Schottky diode measuring with multimeter in diode mode

Schottky diode reference numbers is D7, D8, D705, D706, D707, D708; Voltage drop value should be about 0,159V for D7 and D8, and 0,215V for D705, D706, D707, D708

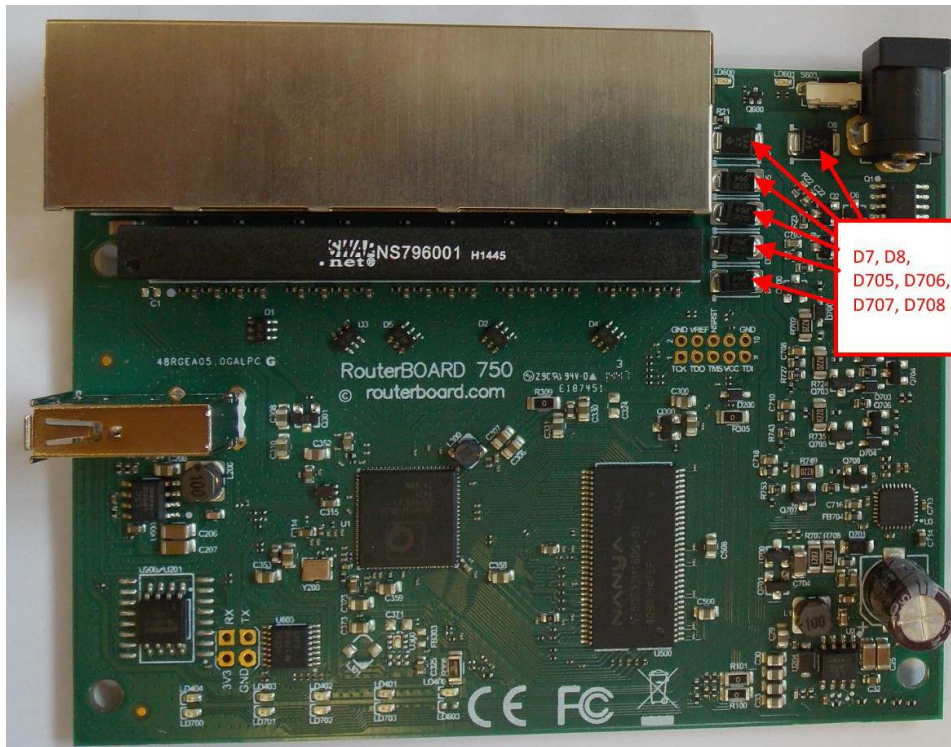

Voltage drop between diode array pin#1 and Ground.

Check voltage drop between TR1 Ethernet Transformers on ports Ether1 – Ether5 pins and Ground. Ether Pins are circled red.

It should be in the range from 0,32V to 0,438V



75R termination resistors resistance

Red circled resistors resistance should be 75Ohm +/- 1%

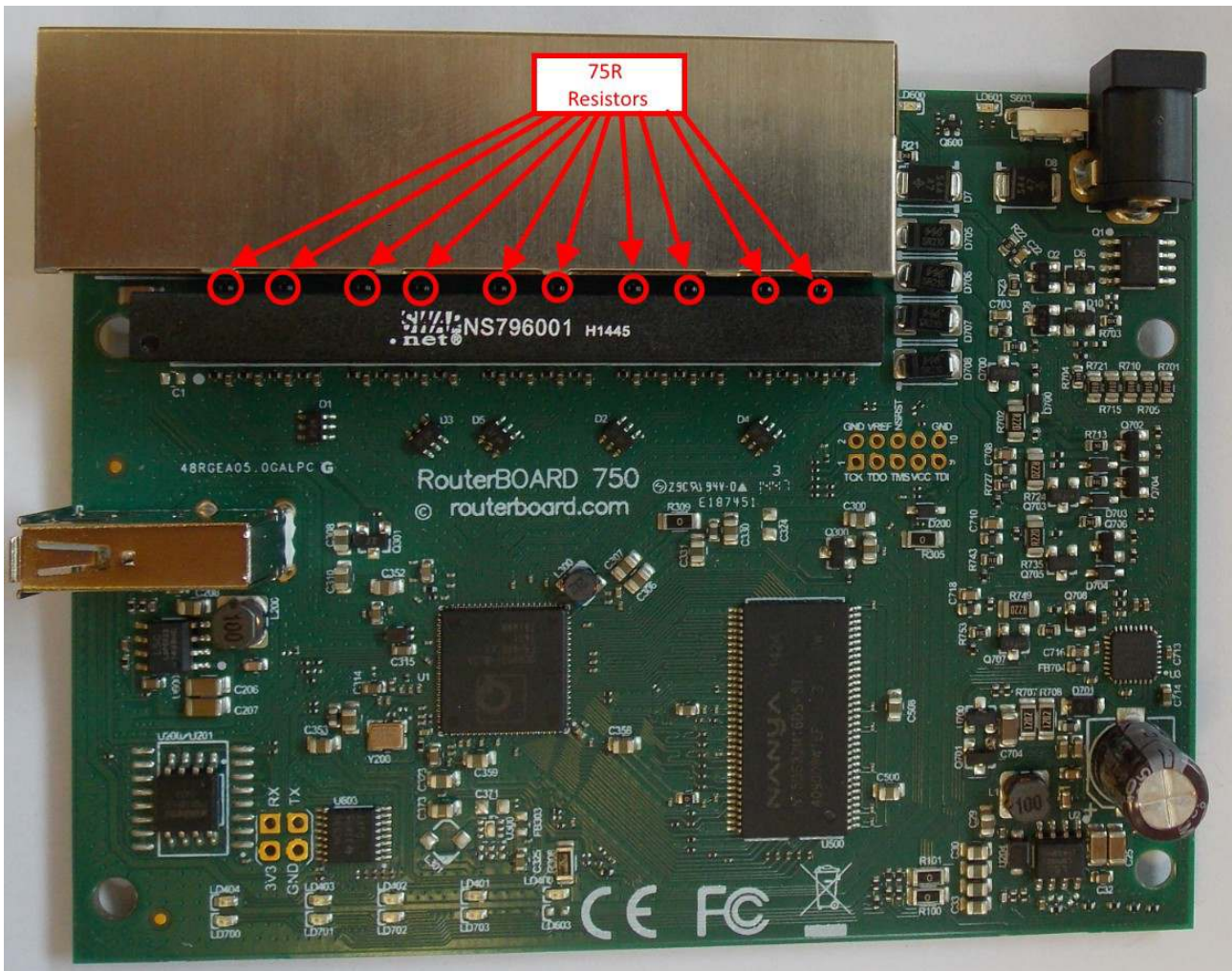

RB922GS-5HPac series RouterBoards

RB922GS-5HPac series:

NetMetal 5



QRT 5 ac



RB922UAGS-5HPacD

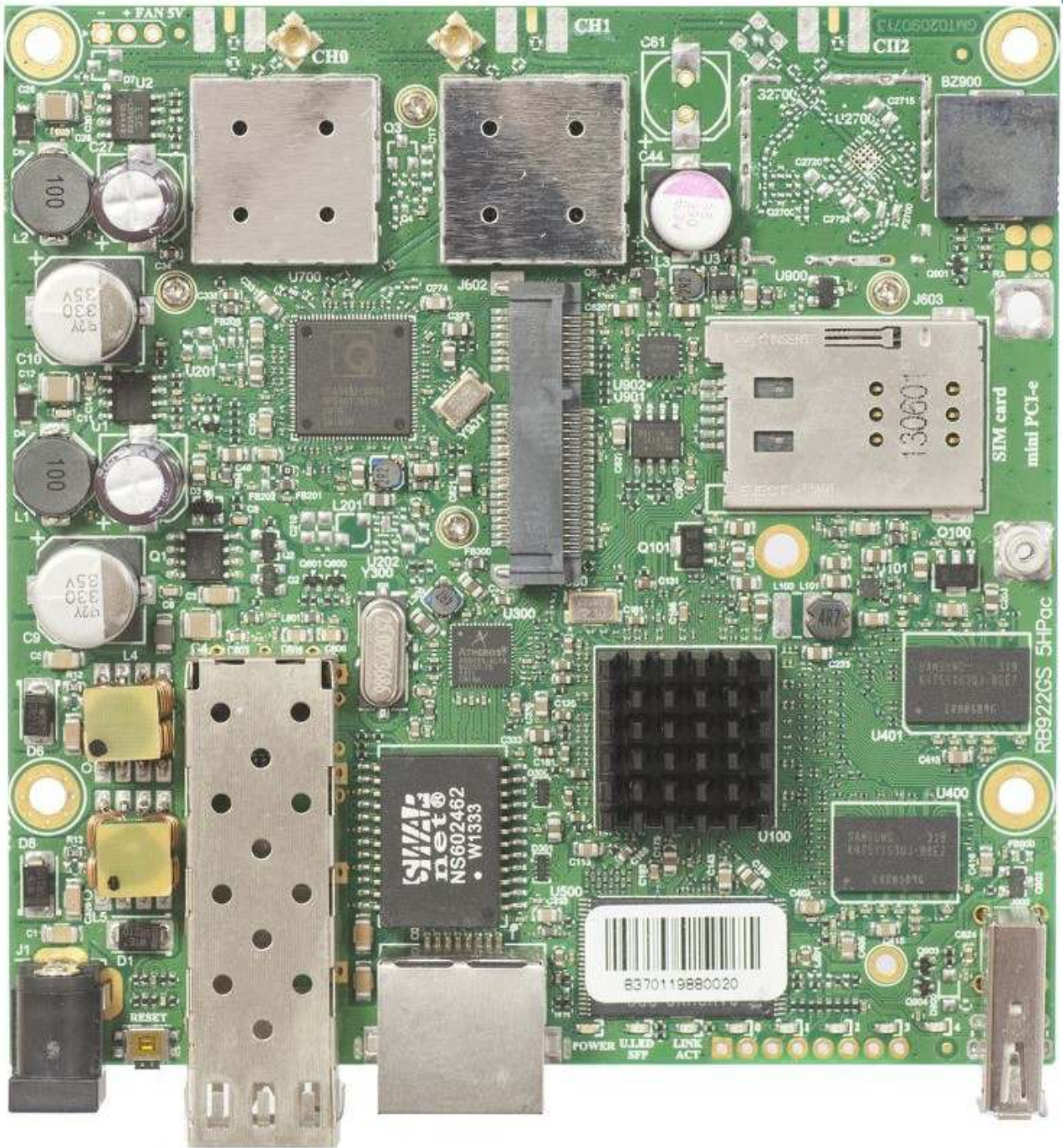

RB911G-5HPacD

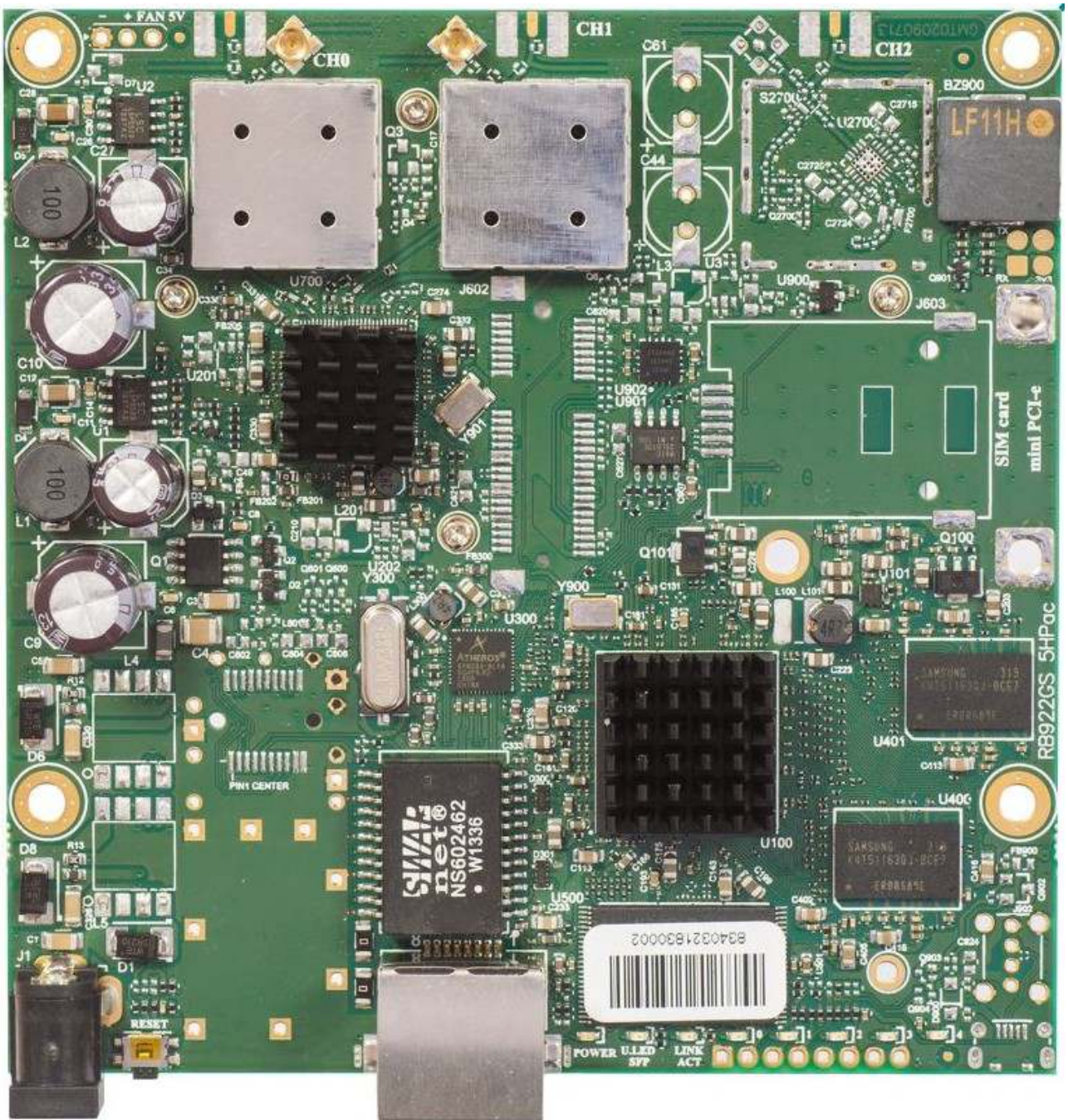

Disassembling information

QRT 5 ac disassembling.

1. step

Remove the wing nut from Ground M4 screw

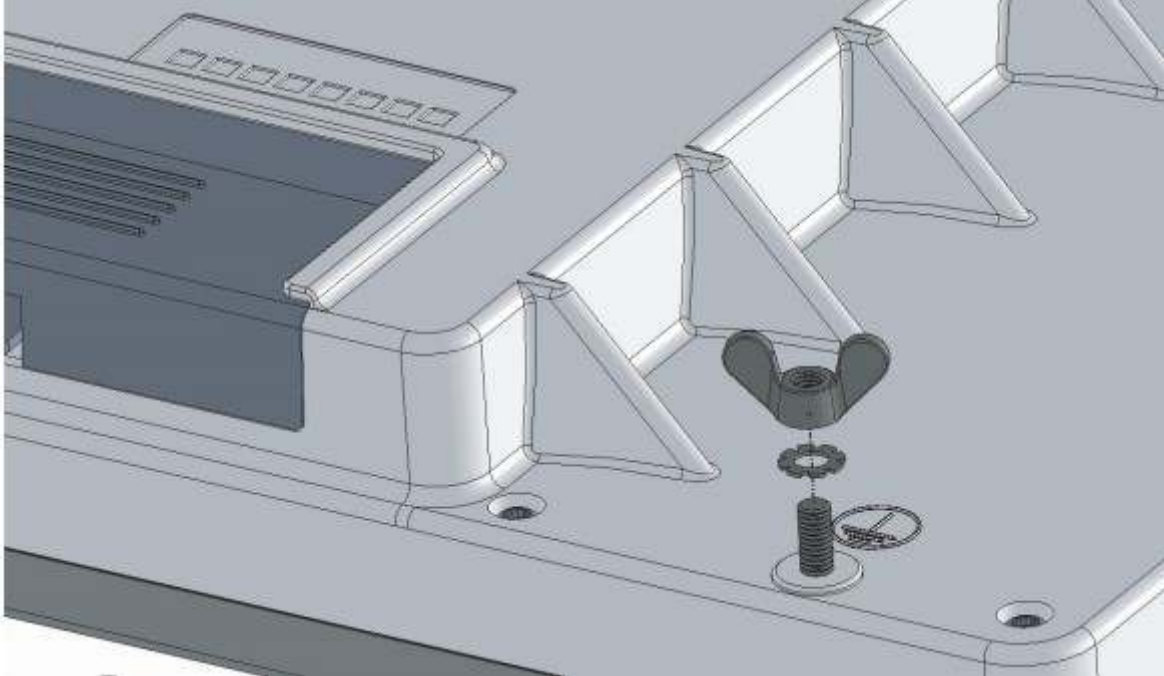

2. step

Remove the 12 pcs screws with torque screwdriver T8

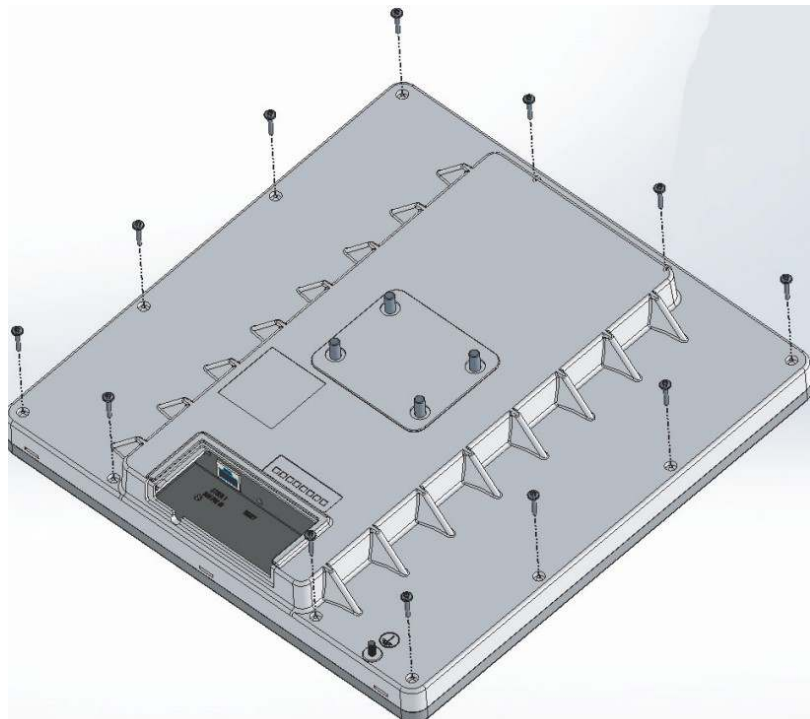

3. step

Remove the cover

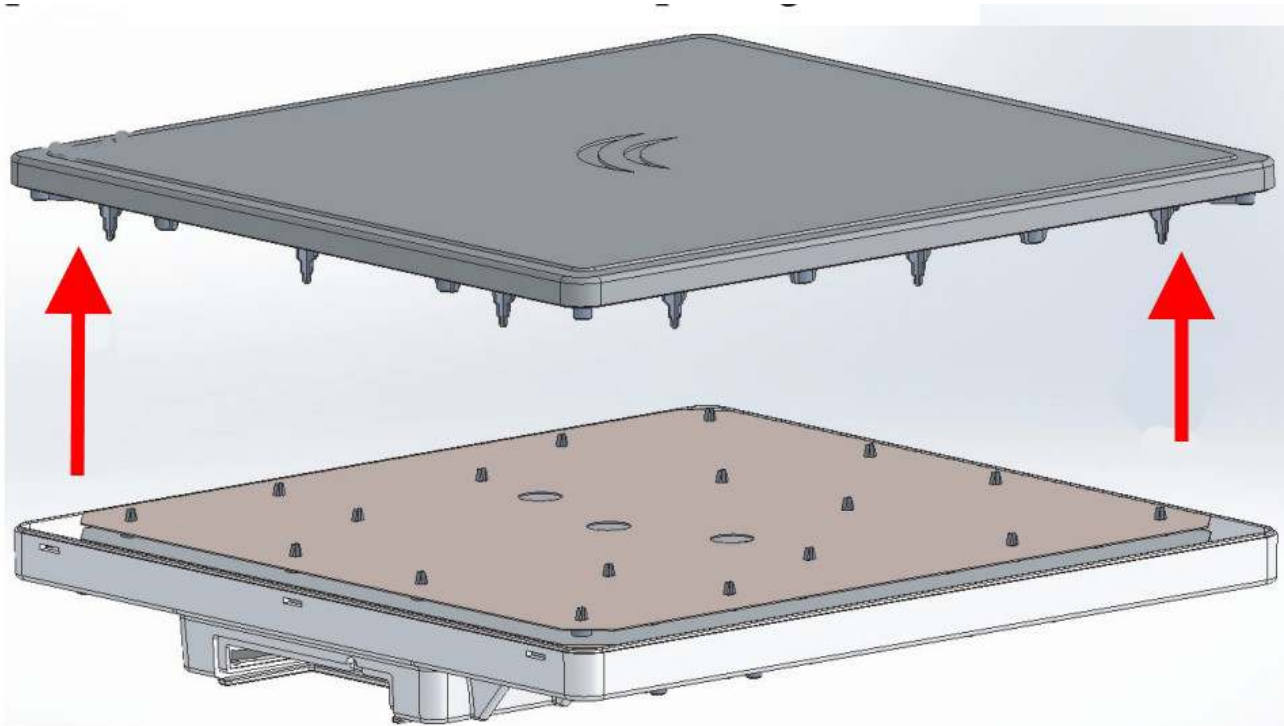

4. step

Remove the M4 screw from bottom plate and than separate bottom plate from antenna with board.

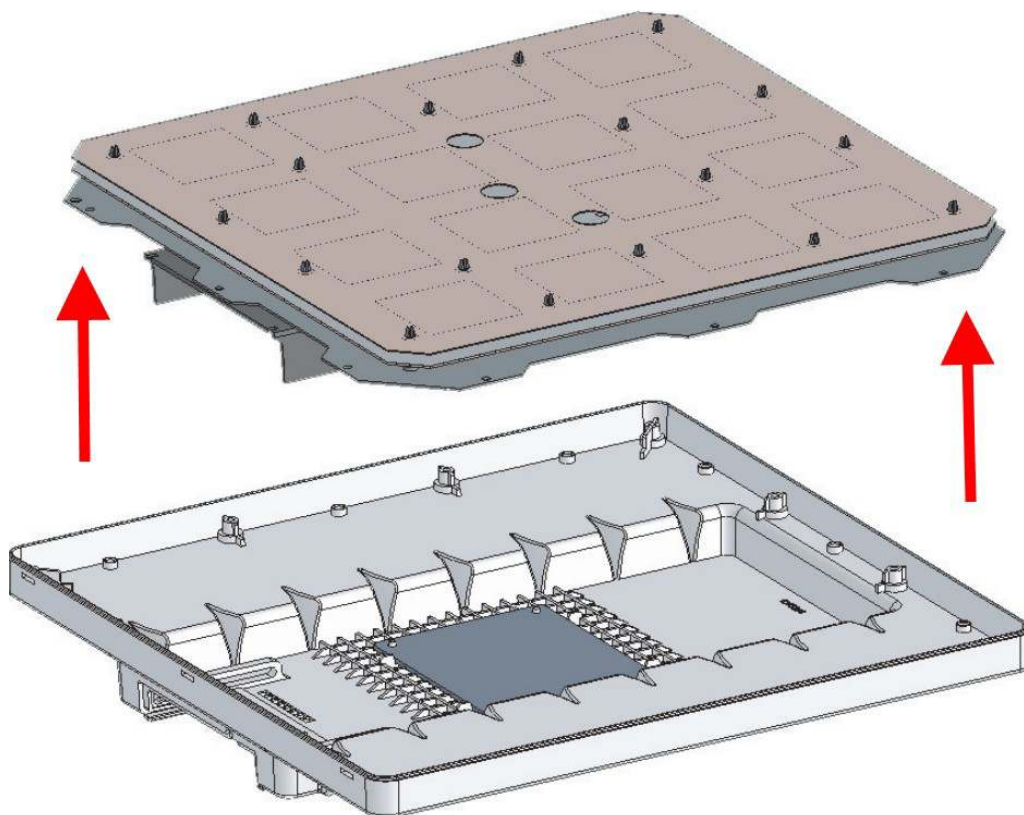

NetMetal 5 disassembling

1. step

Open case and remove label from connectors

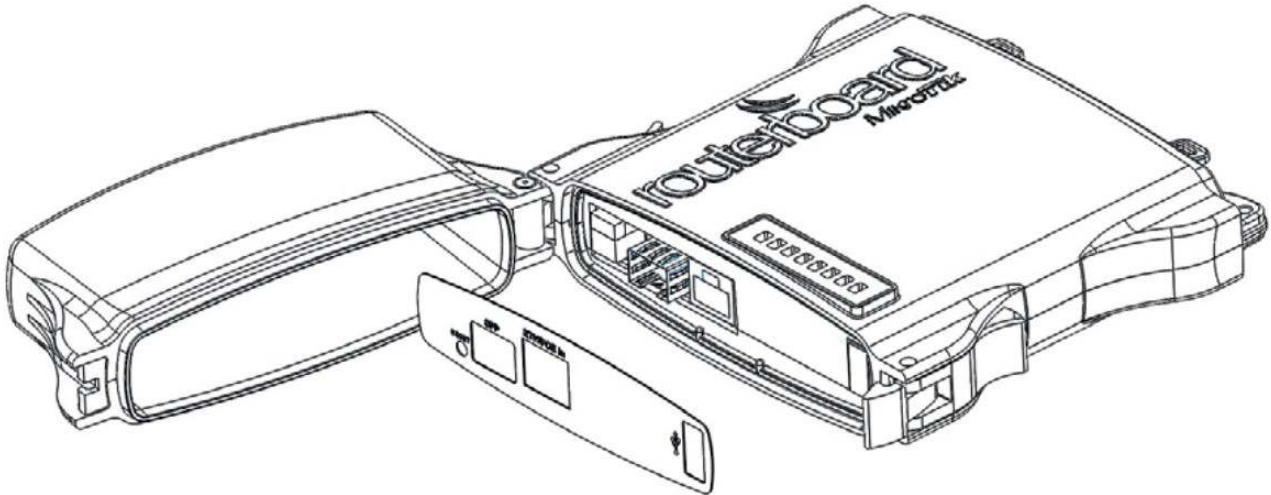

2. step

Remove 4 screws with hexagon key 3 mm screwdriver

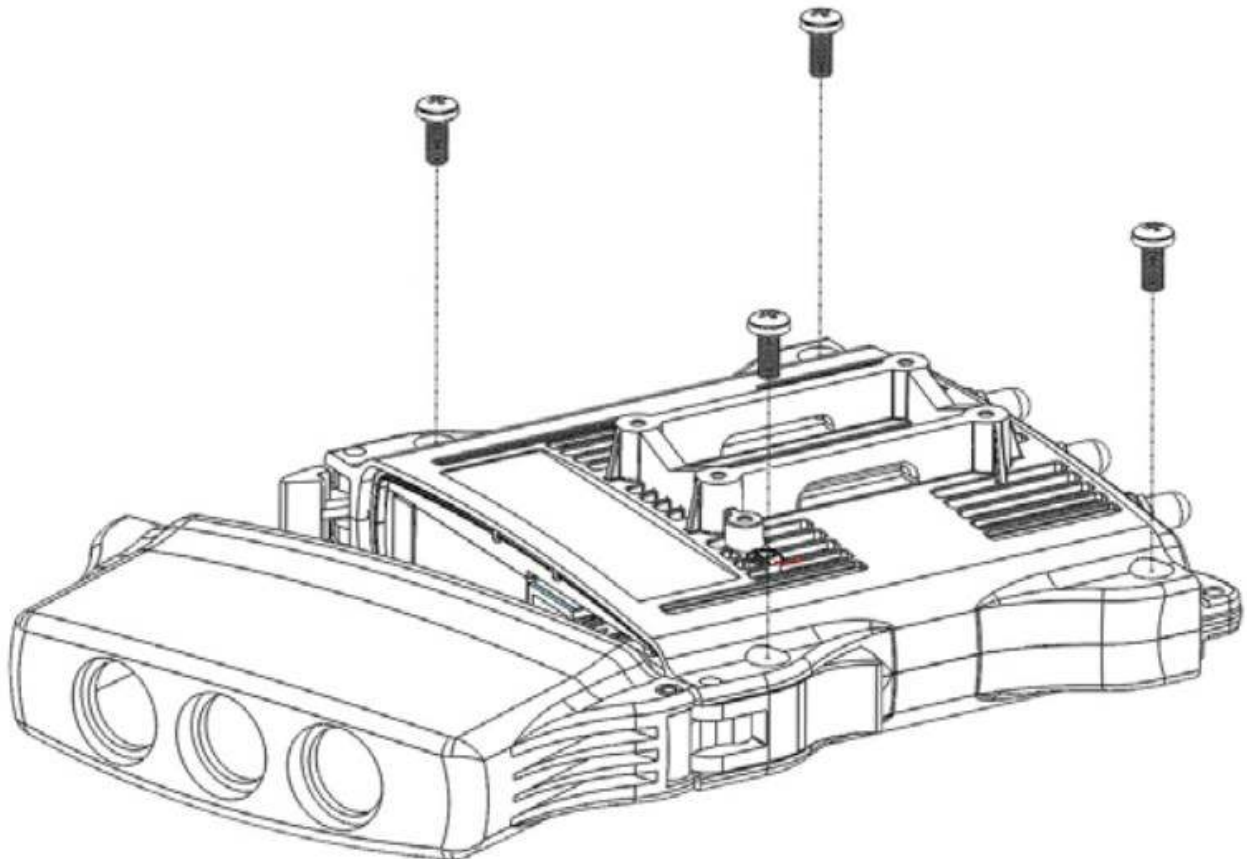

3. Step

Unscrew the PCB from case back with 4 pcs., M3 and 1 pcs., M2 screws

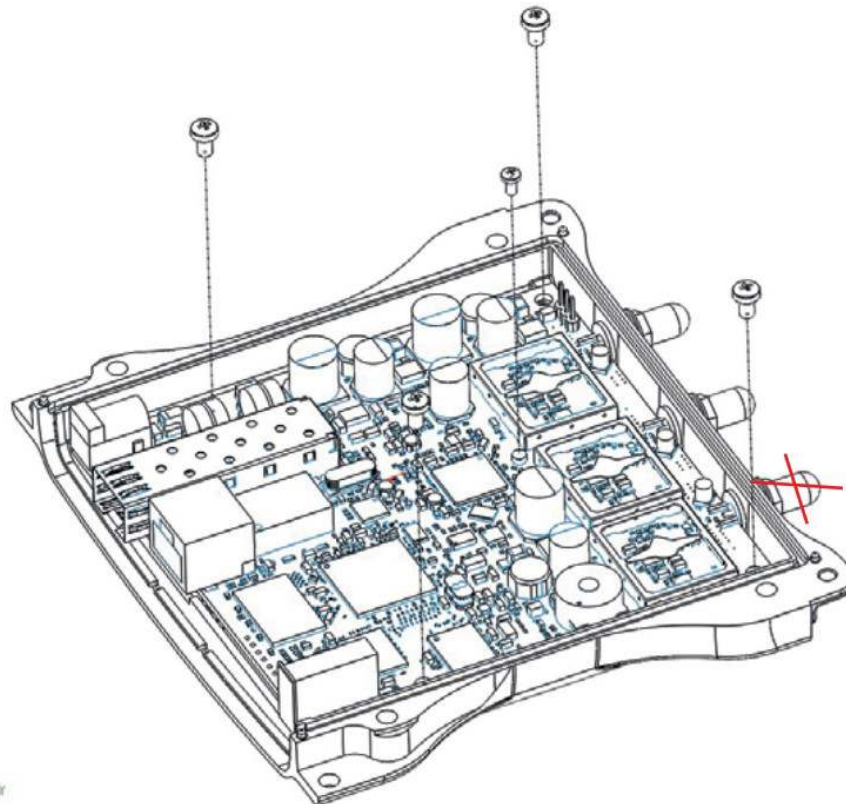

Unscrew the SMA connector nuts with 8 mm wrench.

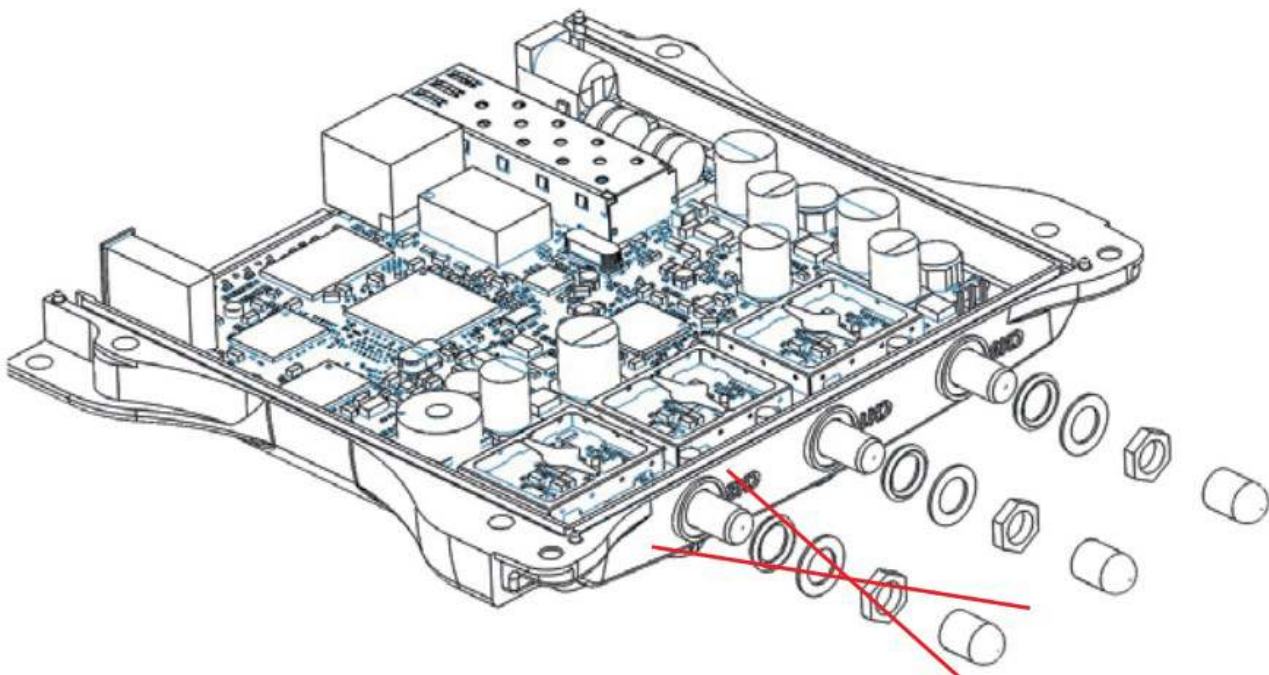

Schottky diode measuring with multimeter in diode mode

Schottky diode reference numbers are D1, D6, D8. Voltage drop value should be about 0,18V

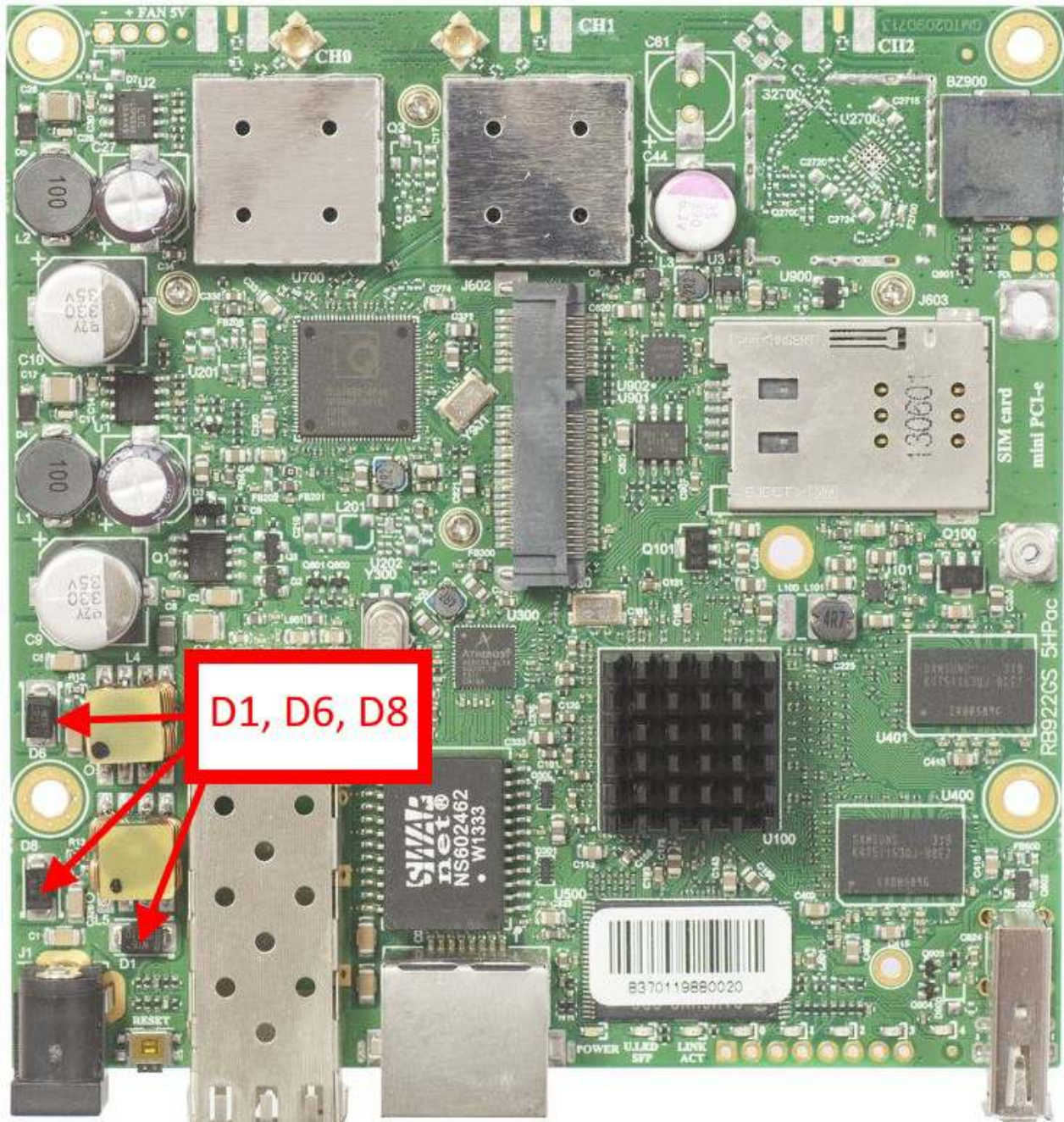

Voltage drop between diode array pin#1 and Ground.

Check voltage drop between TR300 Ethernet Transformers on port Ether1 pins and Ground. Ether Pins are marked with red arrows.

It should be in the range from 0,32V to 0,438V

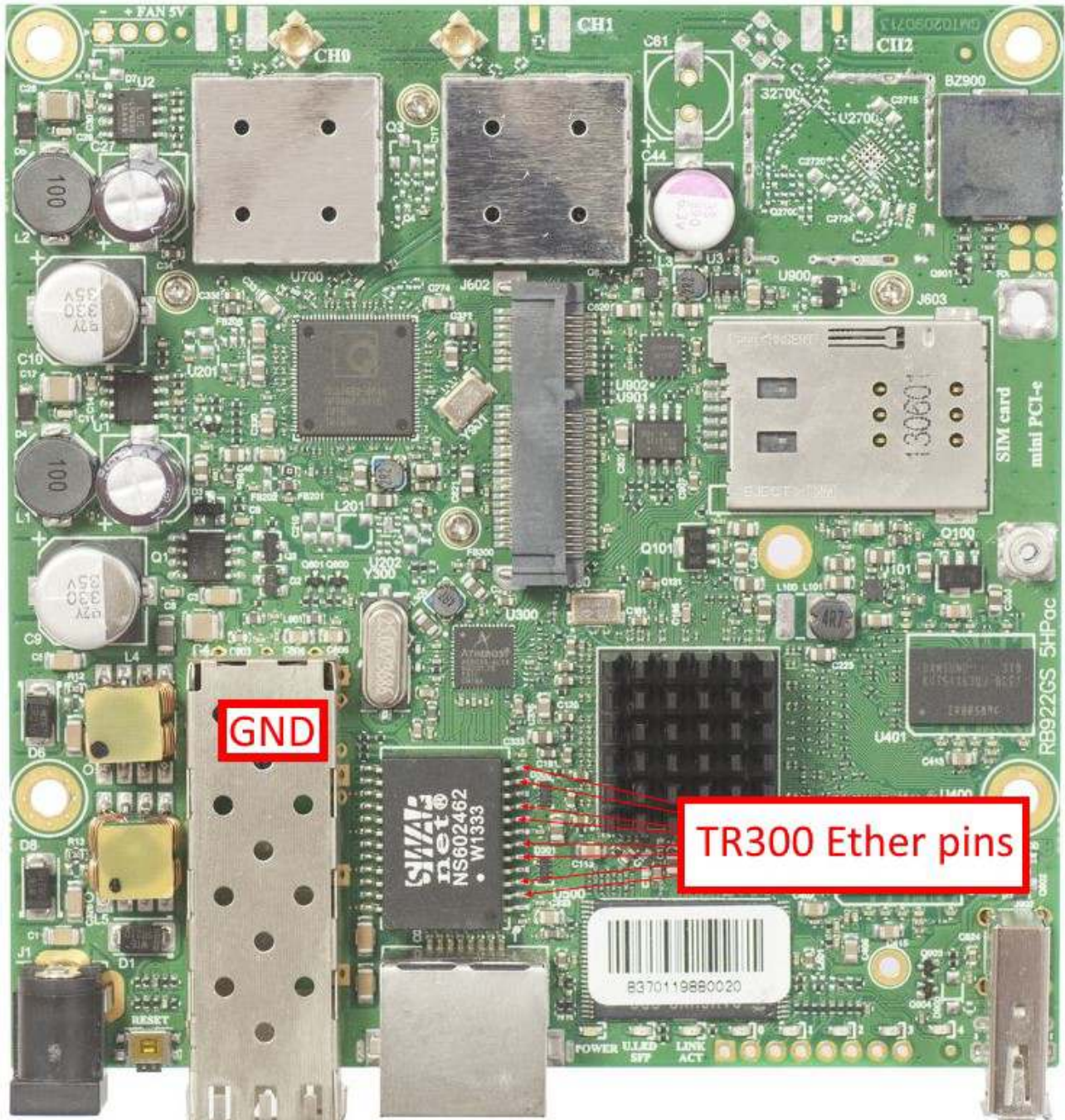

RB921UAGS-5SHPac series RouterBoards

RB921GS-5HPac series:

NetMetal 5



Disassembling information

NetMetal 5 disassembling

1. step

Open case and remove label from connectors

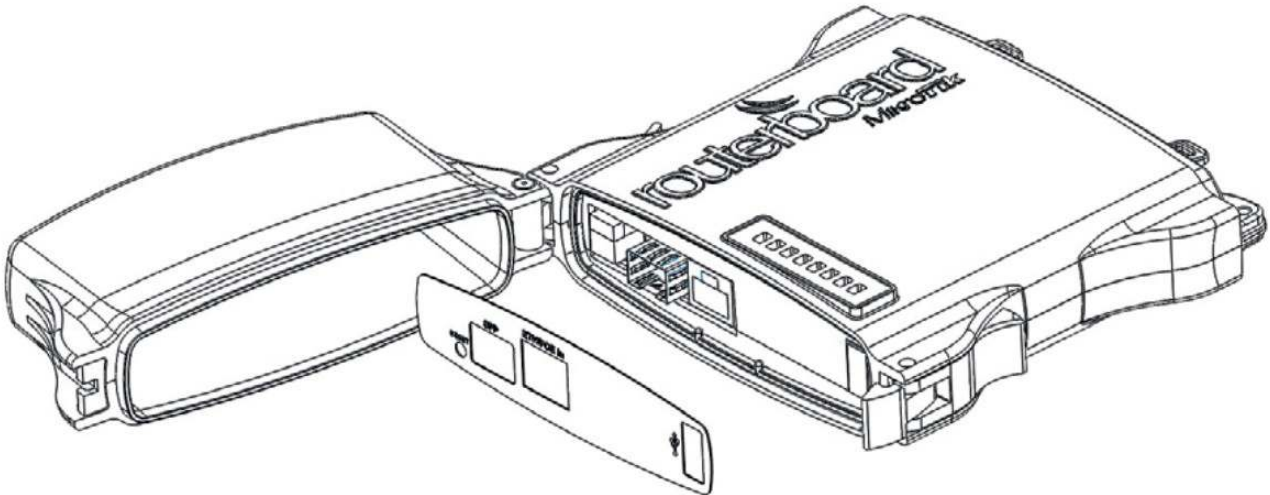

2. step

Remove 4 screws with hexagon key 3 mm screwdriver

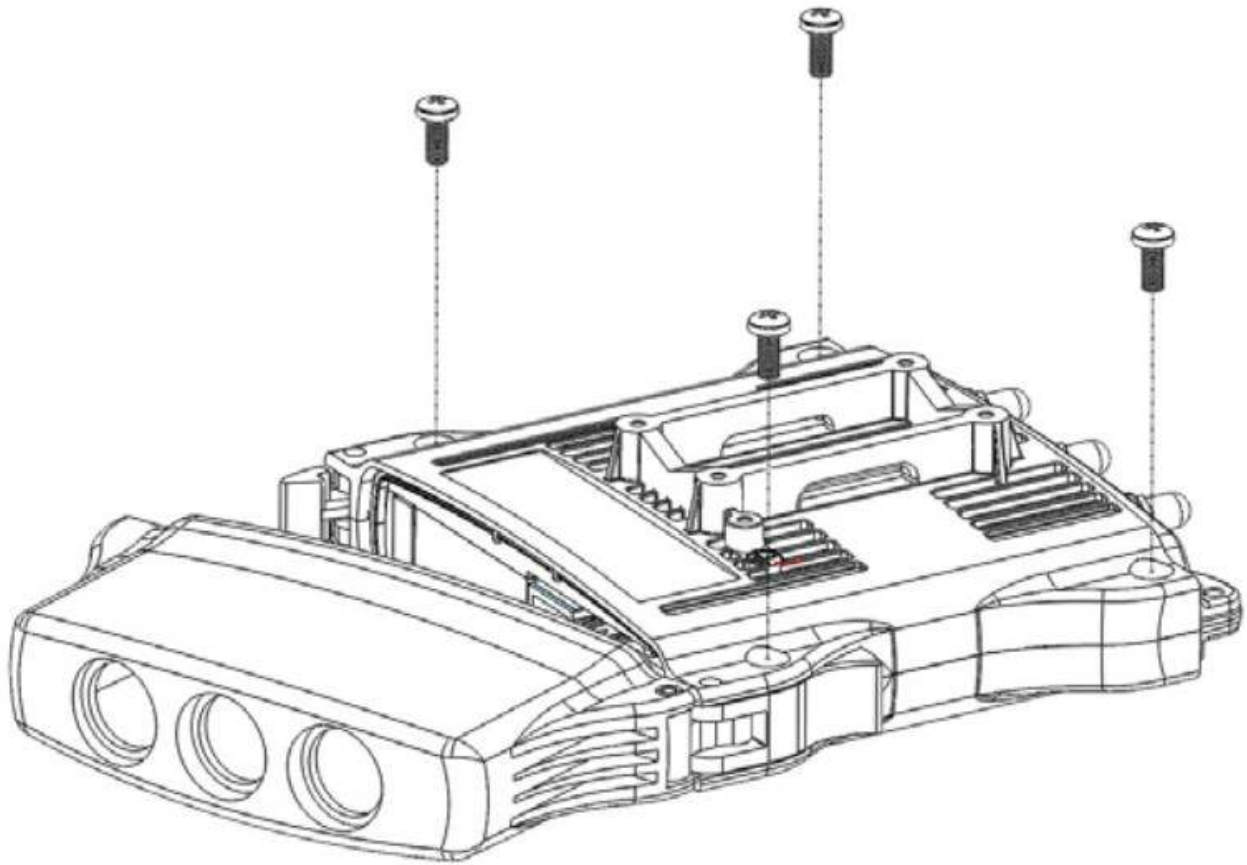

3. Step

Unscrew the PCB from case back with 4 pcs., M3 and 1 pcs., M2 screws

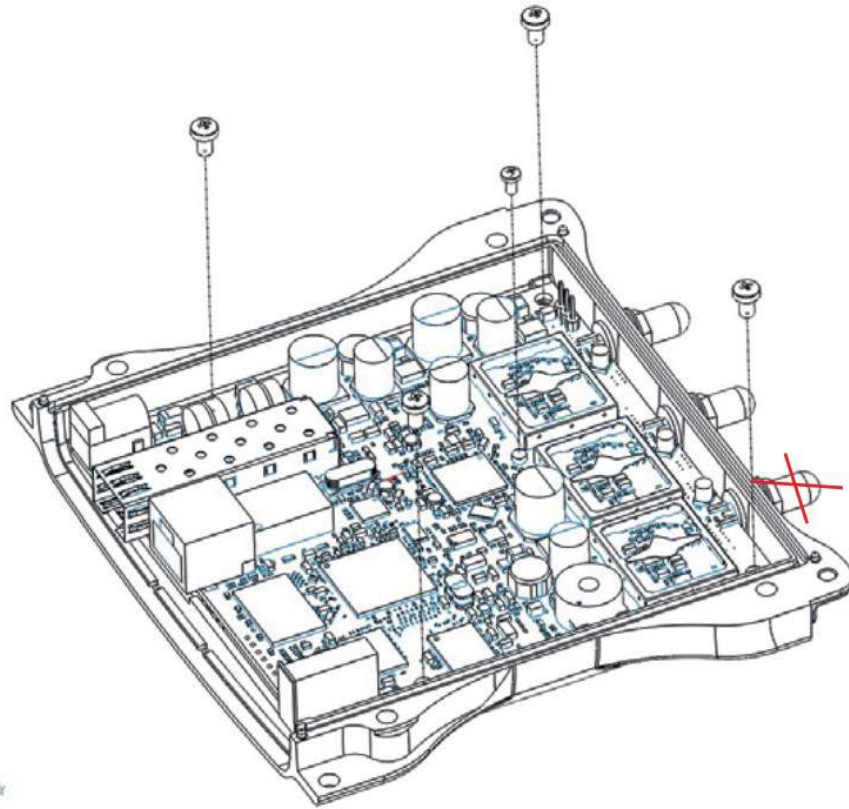

Unscrew the SMA connector nuts with 8 mm wrench.

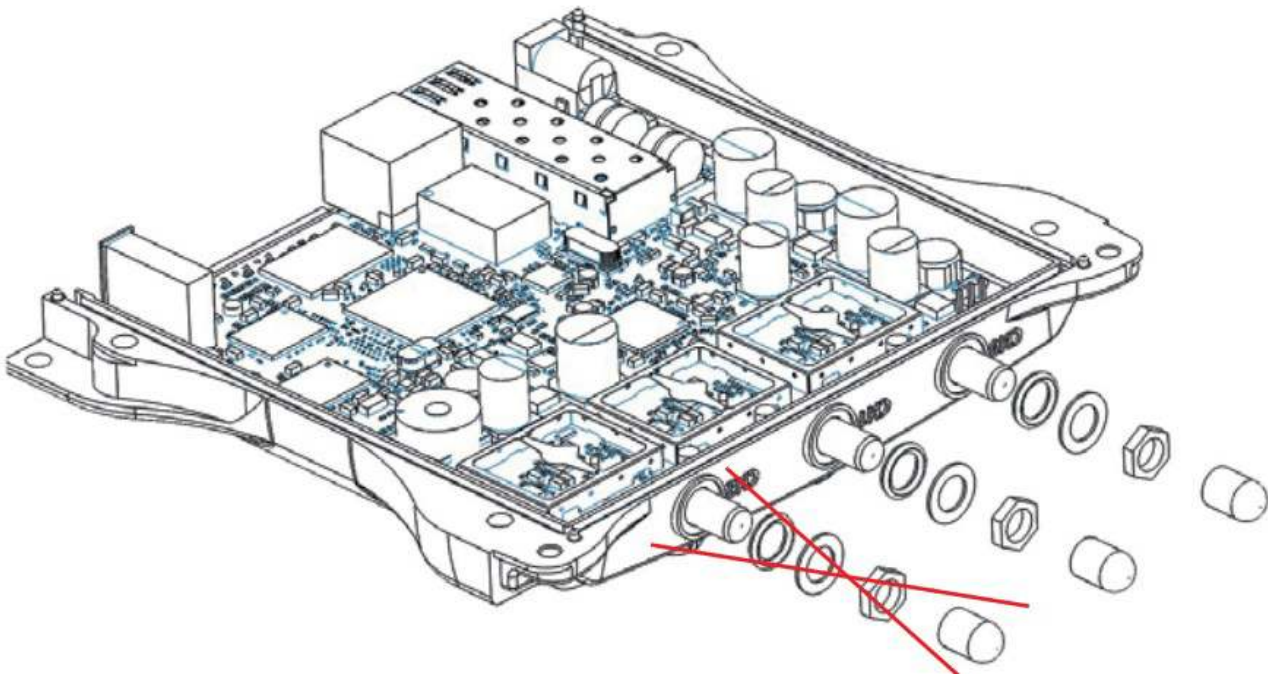

Schottky diode measuring with multimeter in diode mode

Schottky diode reference numbers are D8. Voltage drop value should be about 0,18V

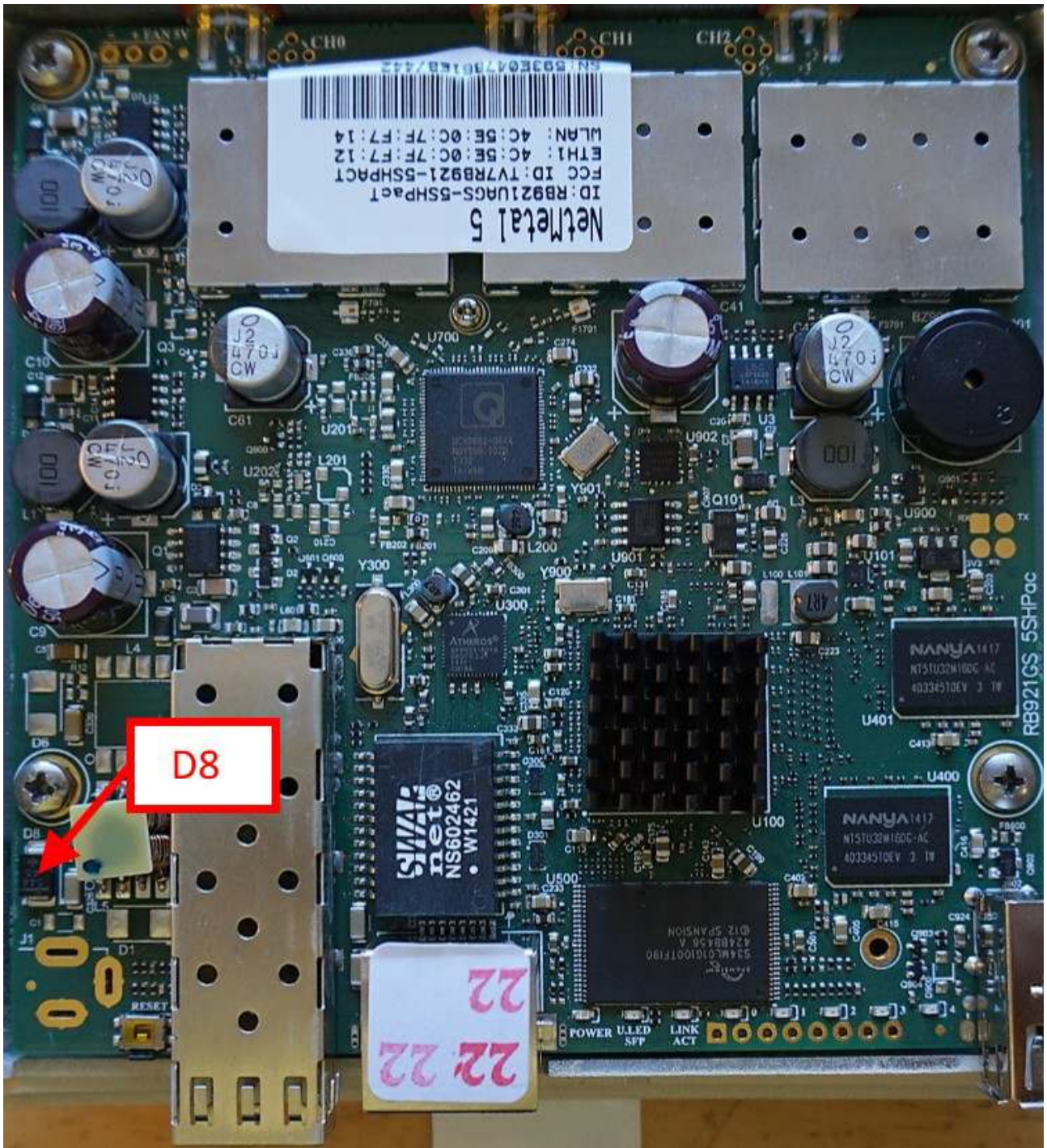

Voltage drop between diode array pin#1 and Ground.

Check voltage drop between TRF300 Ethernet Transformers on port Ether1 pins and Ground. Ether Pins are marked with red arrows.

It should be in the range from 0,32V to 0,438V

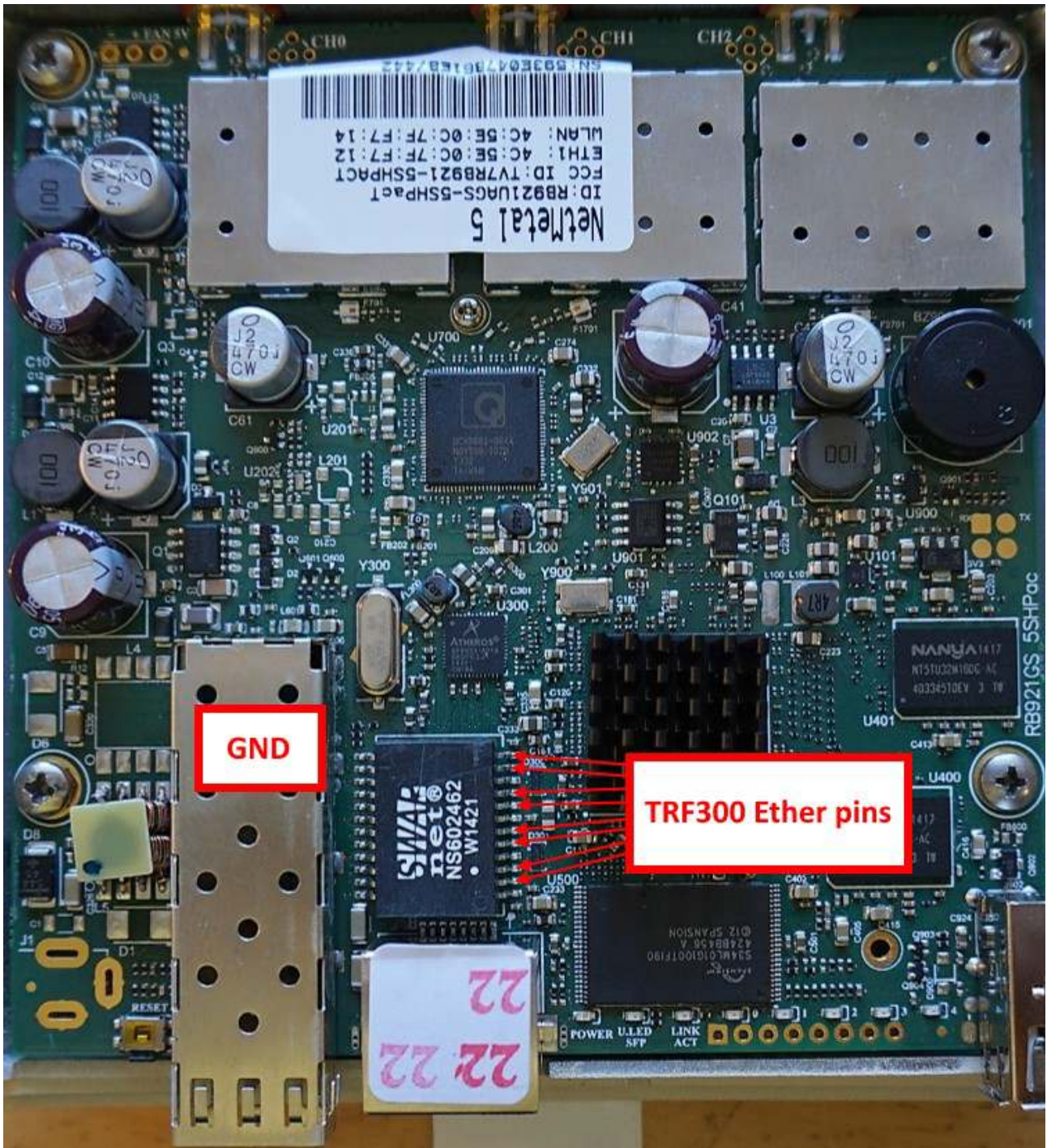

RBmAP series RouterBoards

RBmAP series:

mAP 2n



Disassembling information

mAP 2n disassembling

1. step

Push the white clip to open the case



2. step

Remove front case

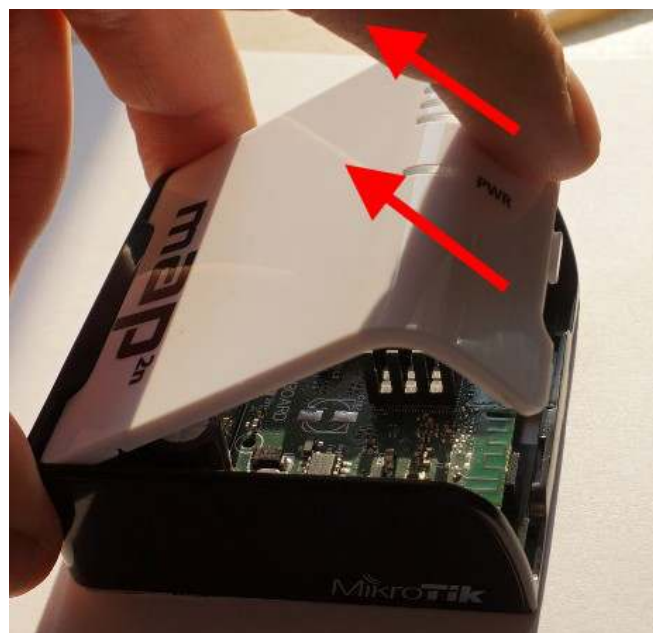

3. Step

Remove board from case

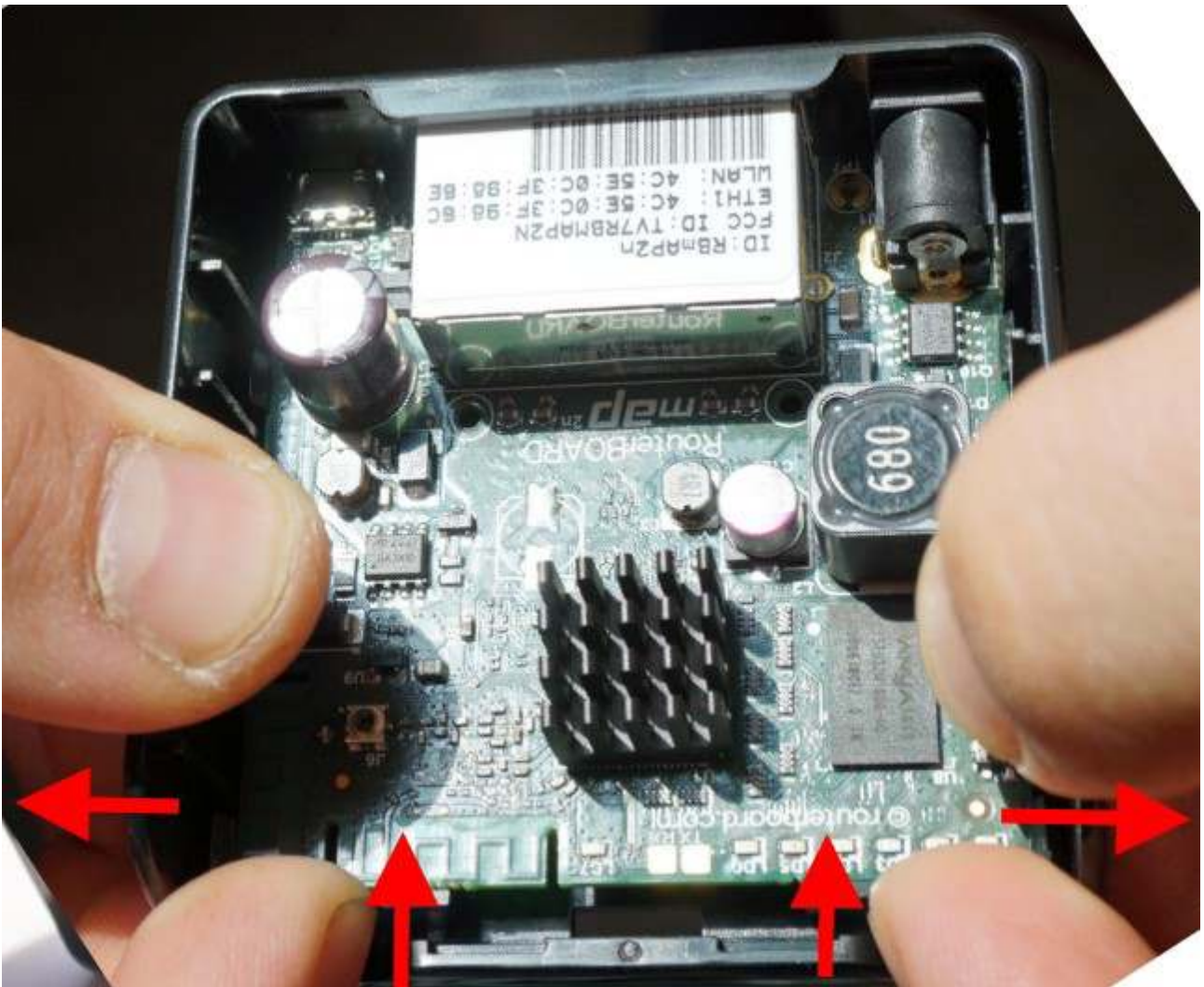

Schottky diode measuring with multimeter in diode mode

Schottky diode reference numbers are D1, D7, D9, D11 on top layer. Voltage drop value should be about 0,35V

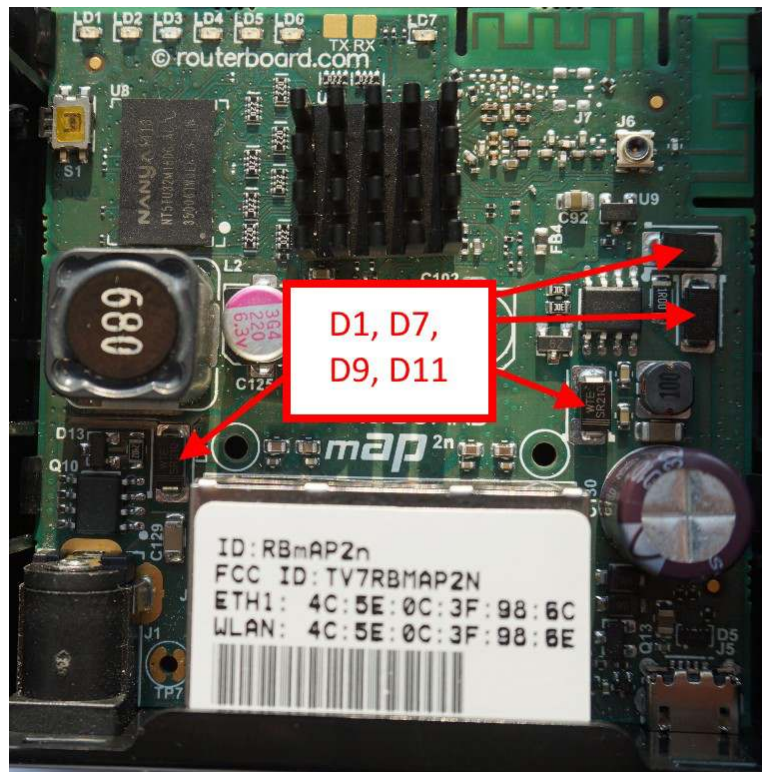

Schottky diode reference numbers are D2, D12 on bottom layer. Voltage drop value should be about 0,35V

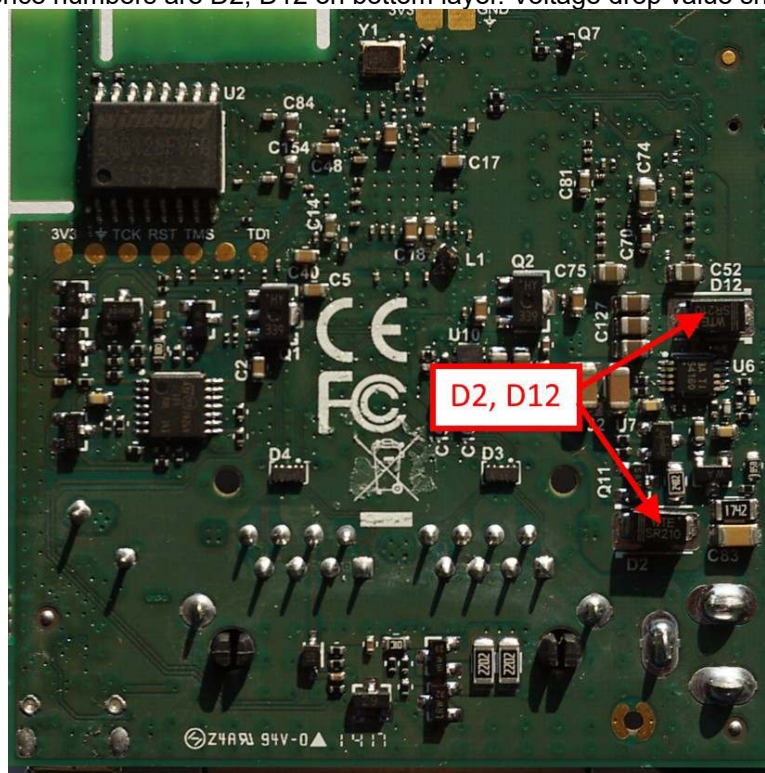

RBcAP series RouterBoards

RBcAP series:

cAP 2n

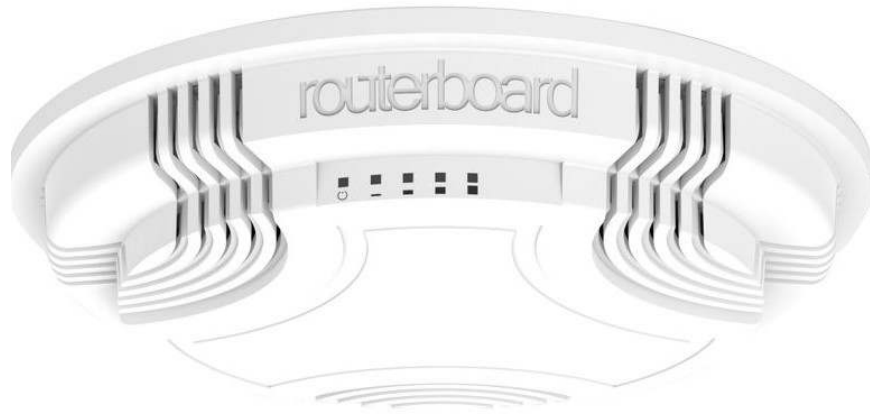

Disassembling information

cAP 2n disassembling

1. step

Push the outer edge around clips to open the case

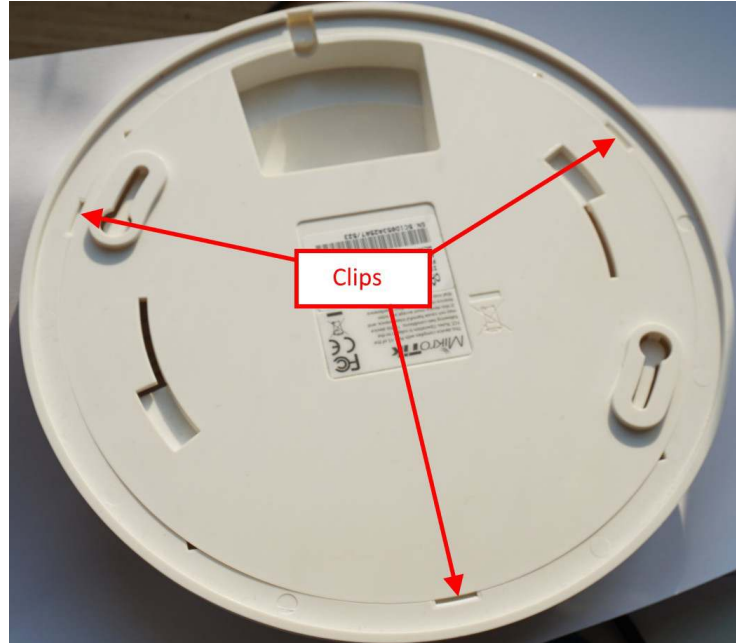

2. step

Remove cover and take out the board from case



Schottky diode measuring with multimeter in diode mode

Schottky diode reference numbers are D1, D3 . Voltage drop value should be about 0,35V

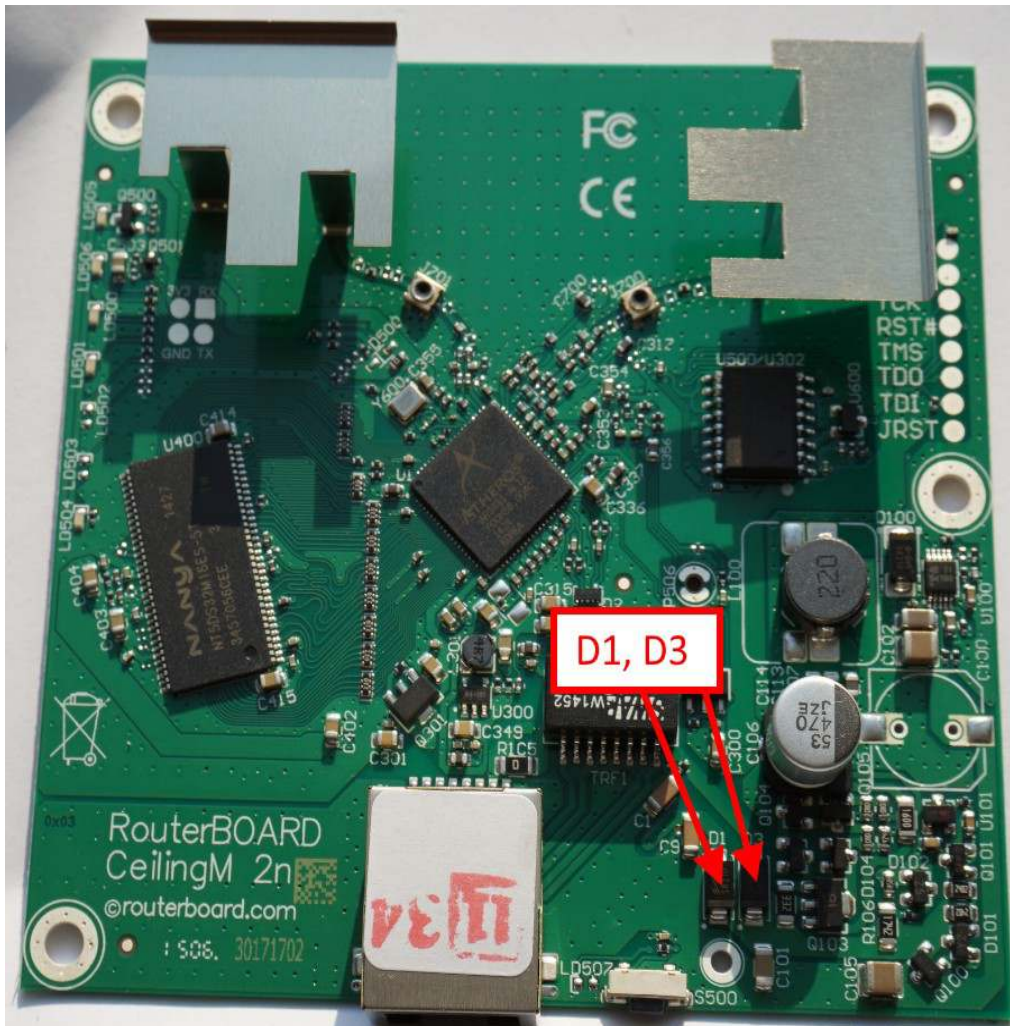

Voltage drop between diode array pin#1 and Ground.

Check voltage drop between TRF1 Ethernet Transformers pins and Ground. Ether Pins are marked with red arrows.

It should be in the range from 0,32V to 0,478V

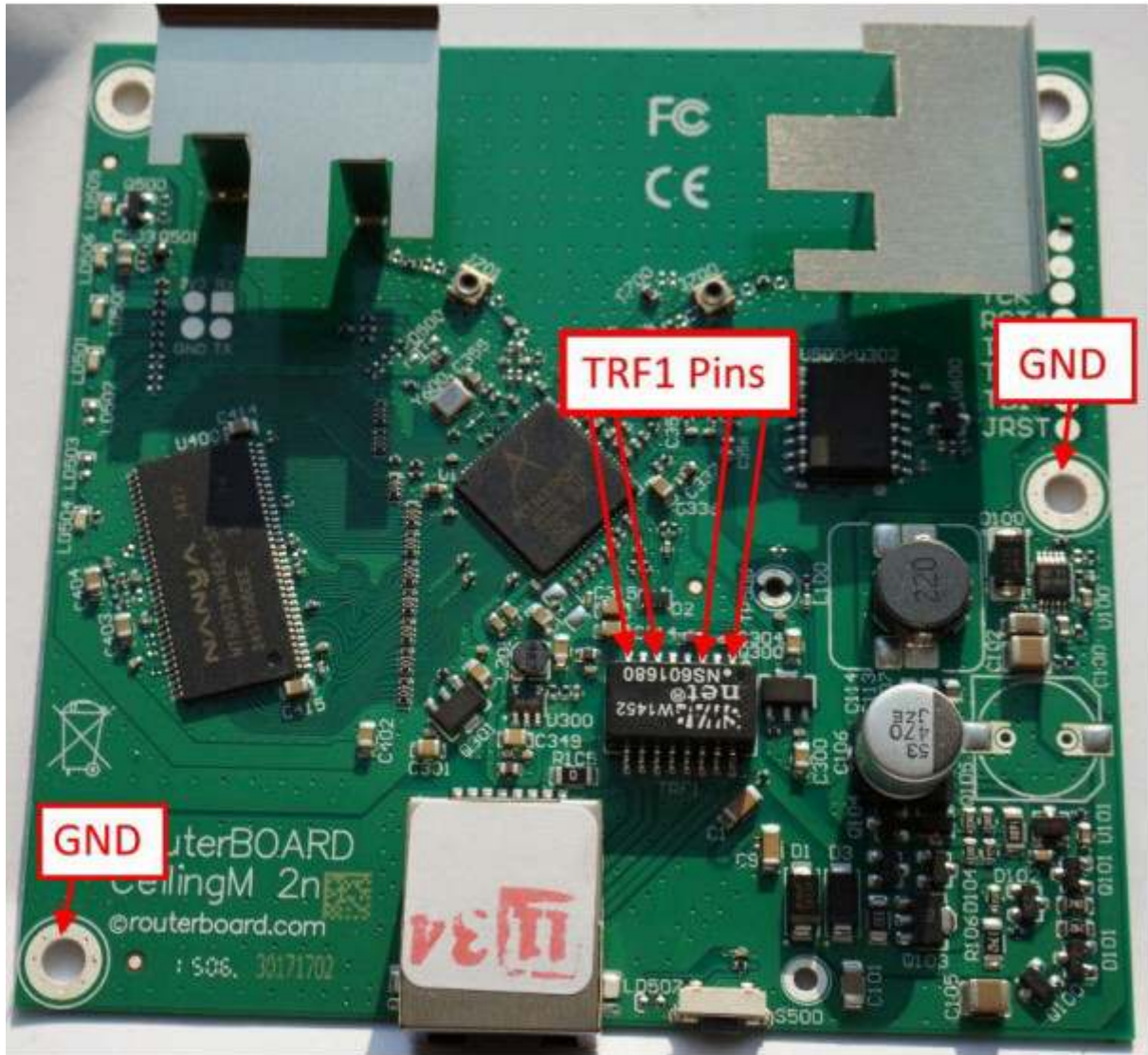

75R Termination resistors resistance.

Resistor resistance, marked with red arrow, should be 75 Ohm +/- 1%

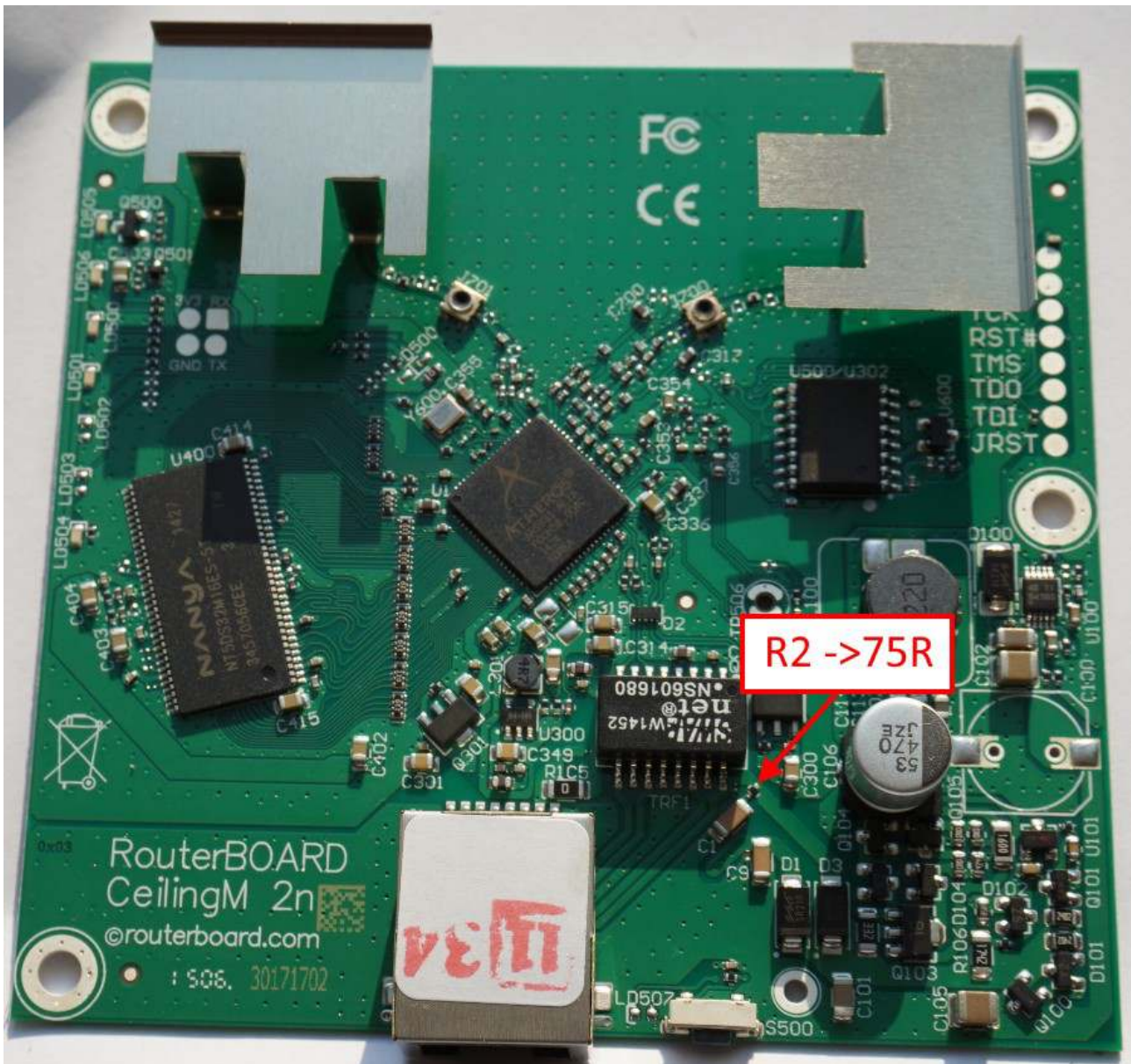

RBDynaDish series RouterBoards

RBDynaDish series:

DynaDish 5



Disassembling information

DynaDish 5 disassembling

1. step

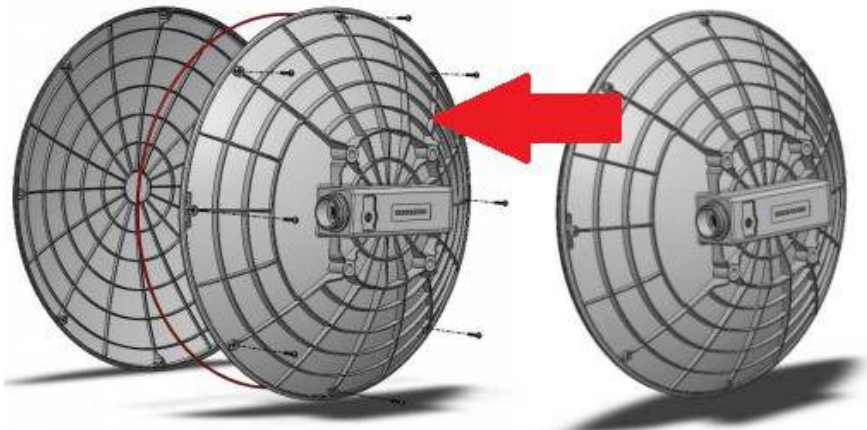

Unscrew 8 pcs screws with TX10 screwdriver and remove the antenna cover as shown in picture

2. step

Unscrew 4 pcs screws with TX10 screwdriver and remove the board from the antenna construction as shown in picture.

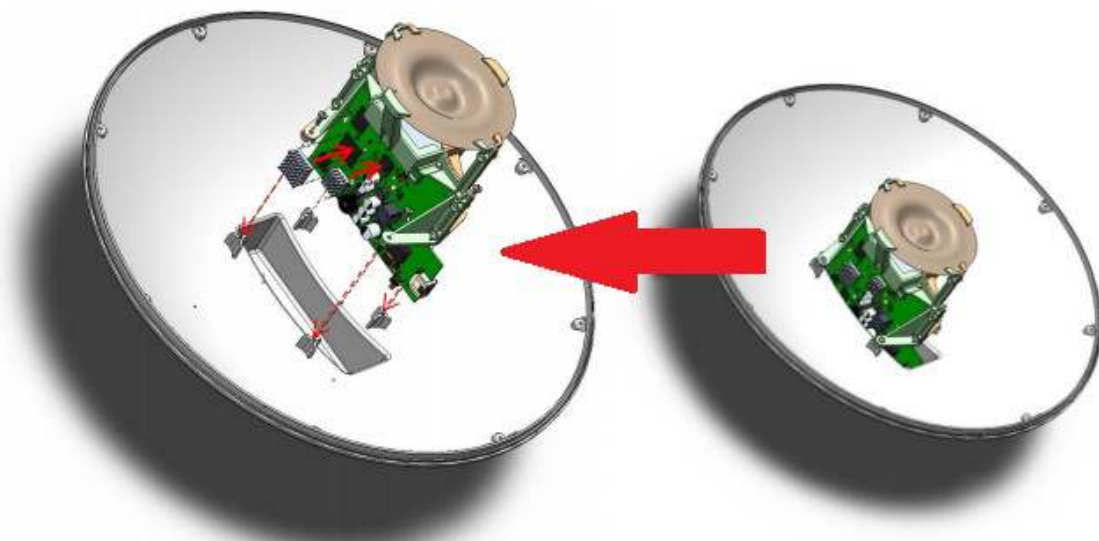

Schottky diode measuring with multimeter in diode mode

Schottky diode reference number is D109; Voltage drop value should be about 0,197V
Diode bridge reference number is D111. Voltage drop value should be about 0,675V

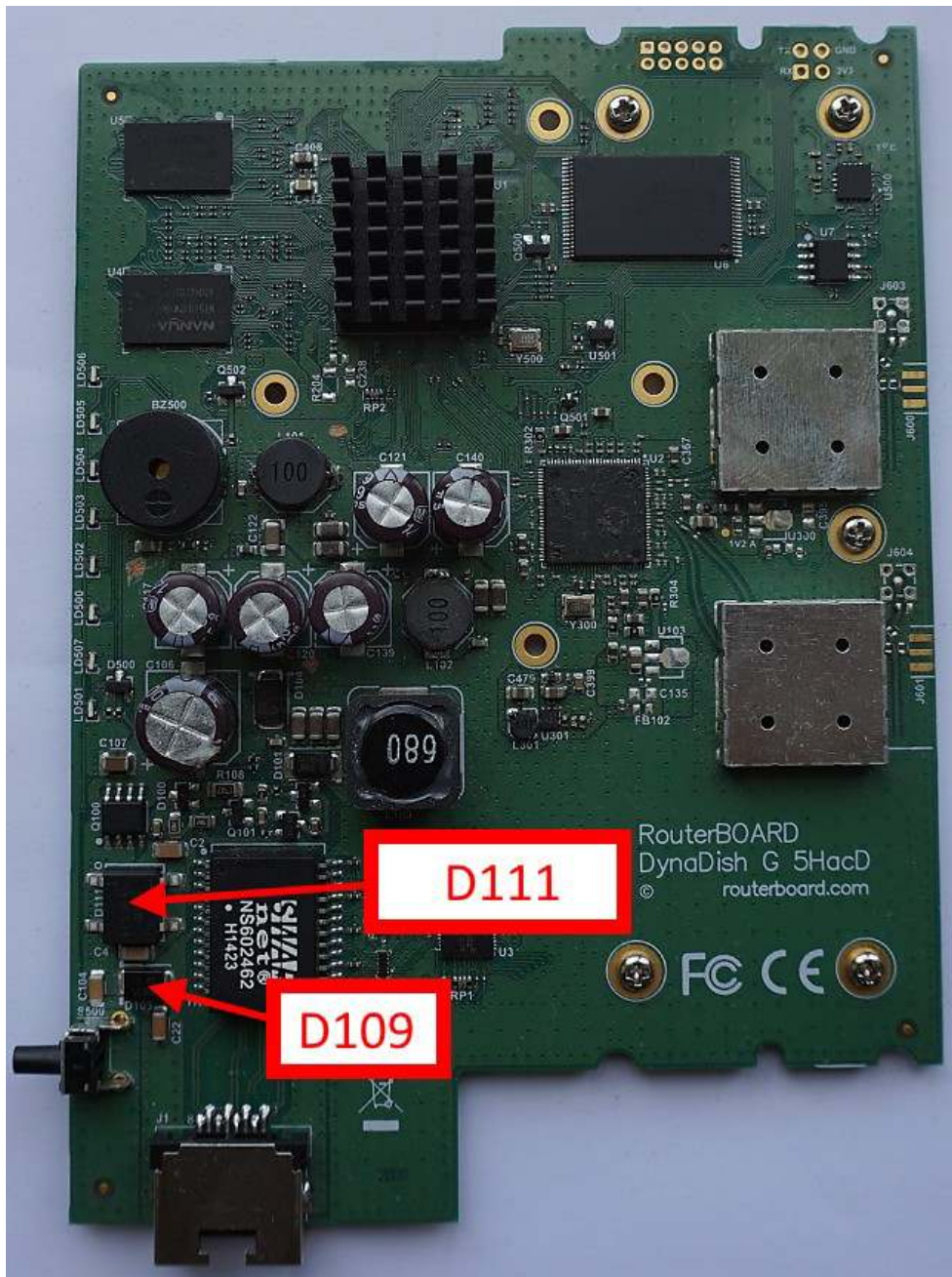

Voltage drop between diode array pin#1 and Ground.

Check voltage drop between TR1 Ethernet Transformers pins and Ground. Ether Pins are marked with red arrows.

It should be in the range from 0,32V to 0,487V

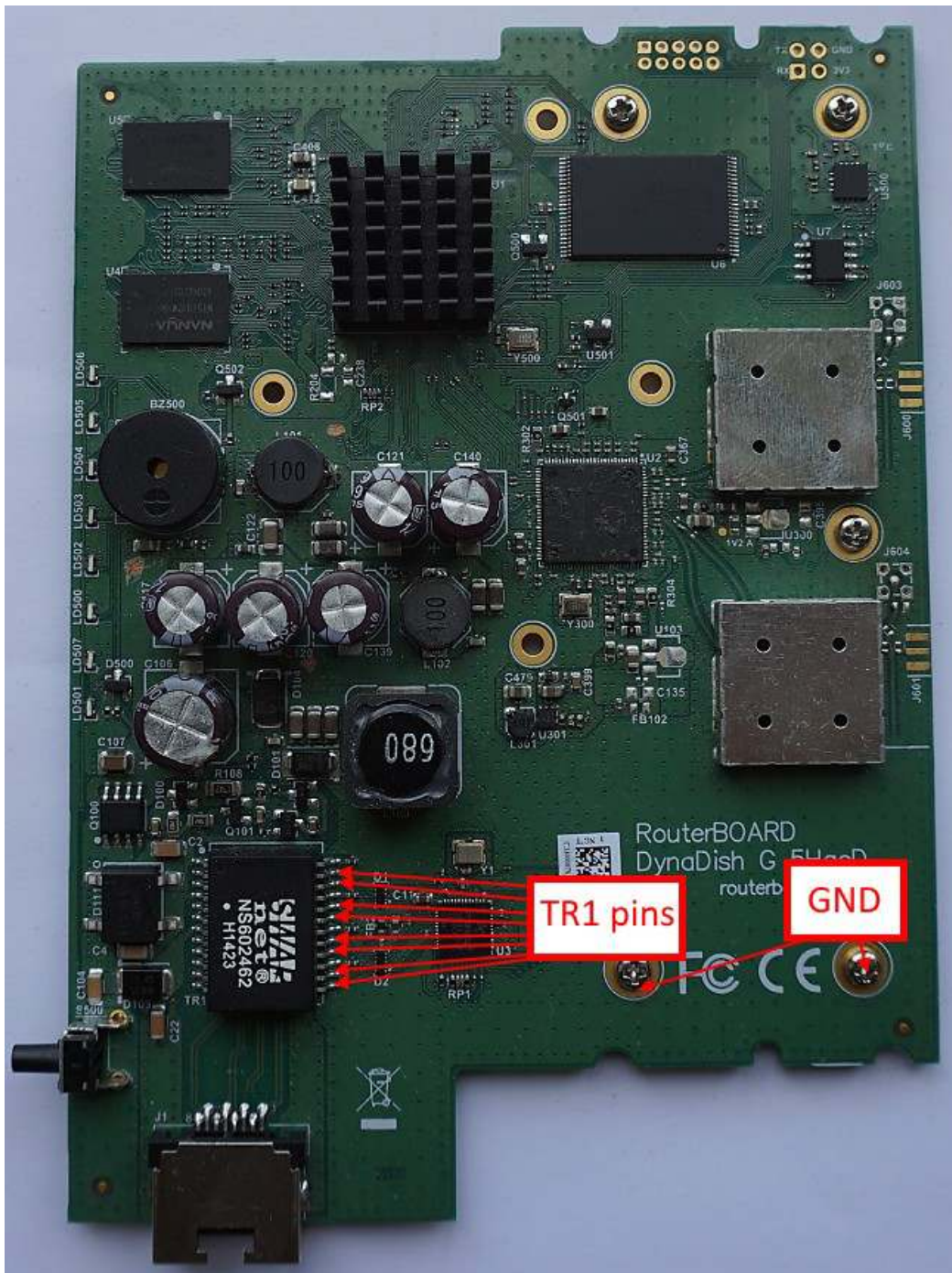

RB953GS-5HnT series RouterBoards

RB953GS-5HnT-RP

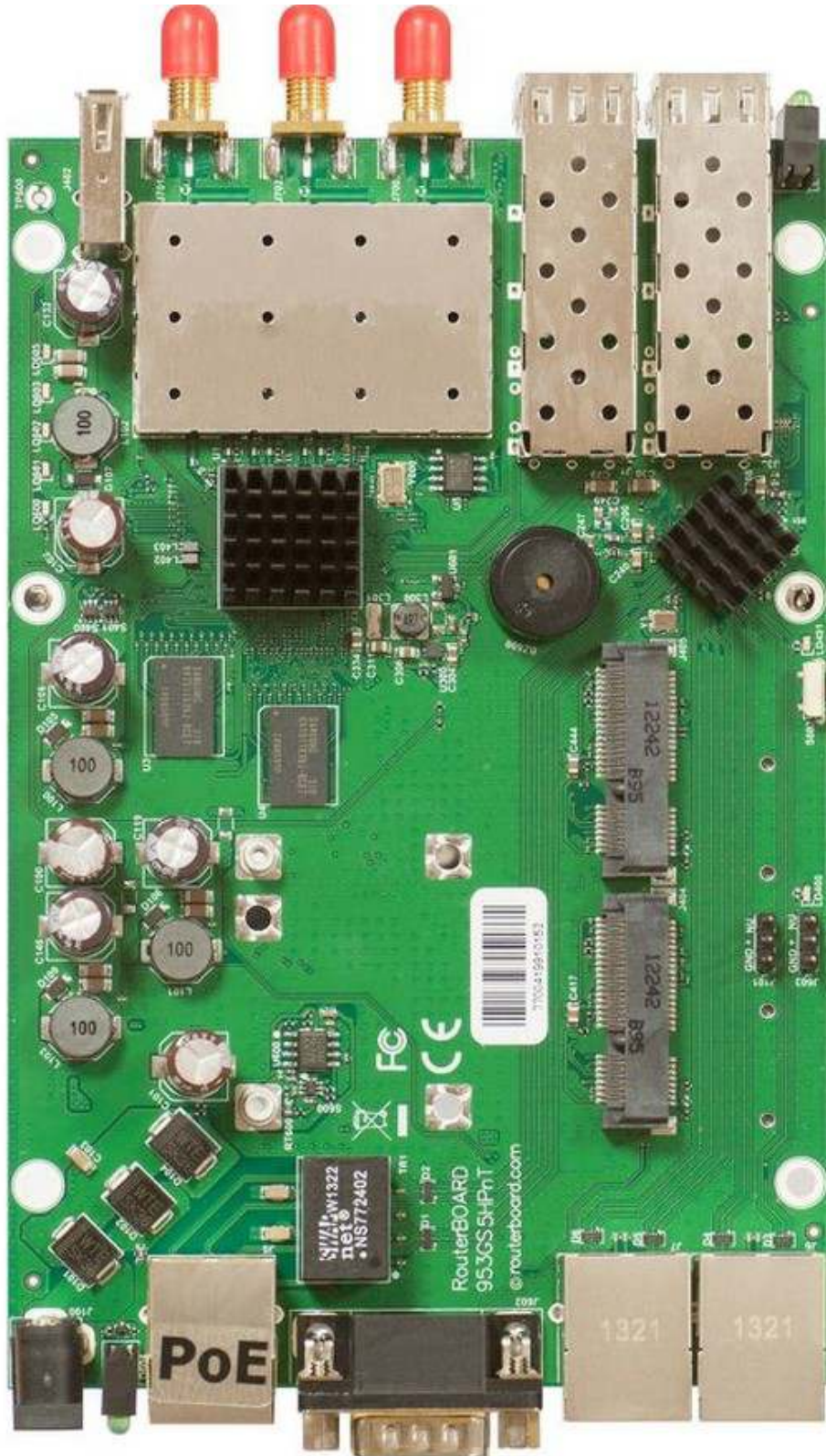

Schottky diode measuring with multimeter in diode mode

Schottky diode reference numbers are D101, D102, D104; Voltage drop value should be about 0,197V



Voltage drop between diode array pin#1 and Ground.

Check voltage drop between TR1 Ethernet Transformers pins and Ground. Ether Pins are marked with red circles.

It should be in the range from 0,32V to 0,589V

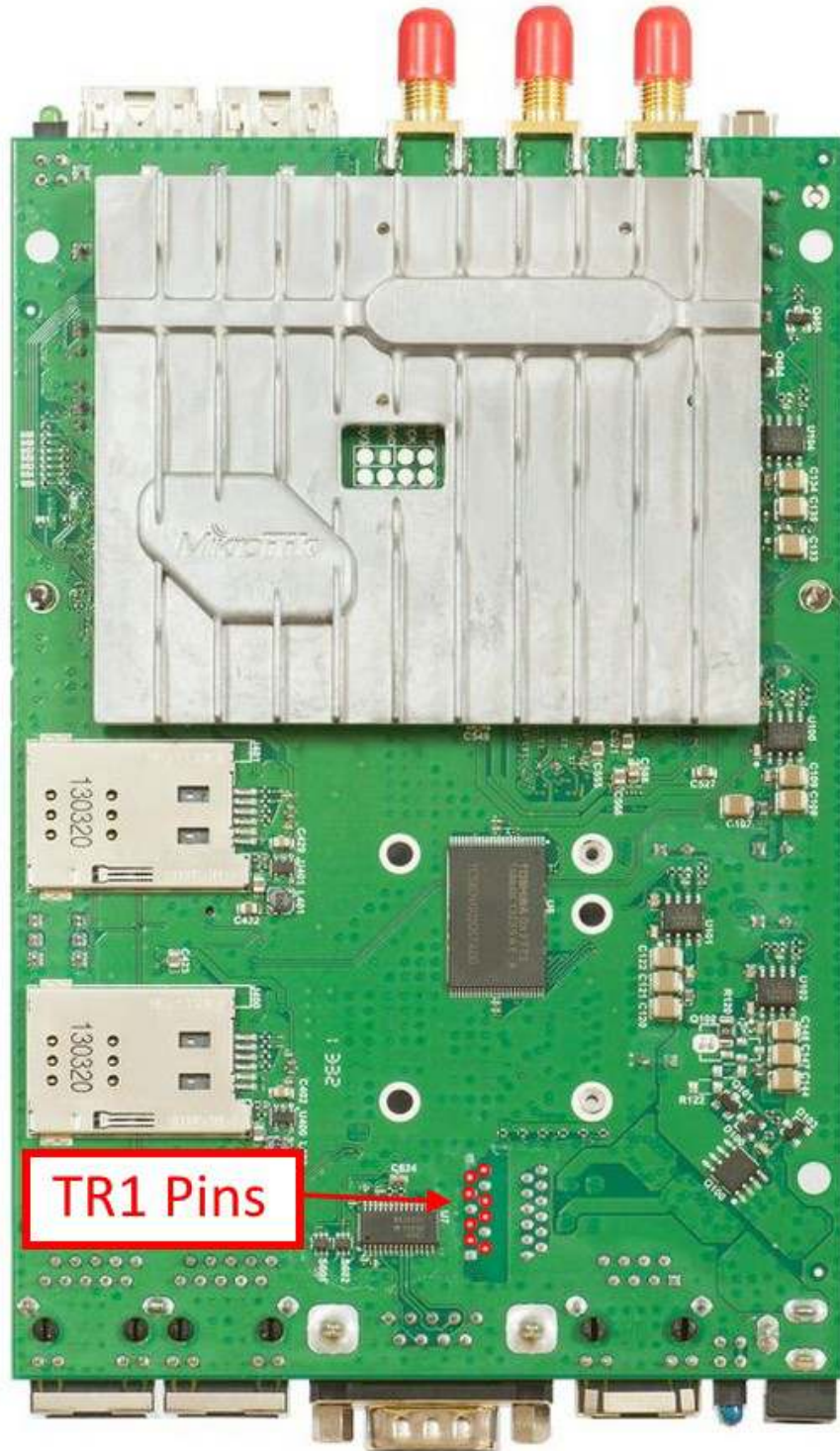

75R Termination resistors resistance.

Resistor resistance, marked with red arrow, should be 75 Ohm +/- 1%

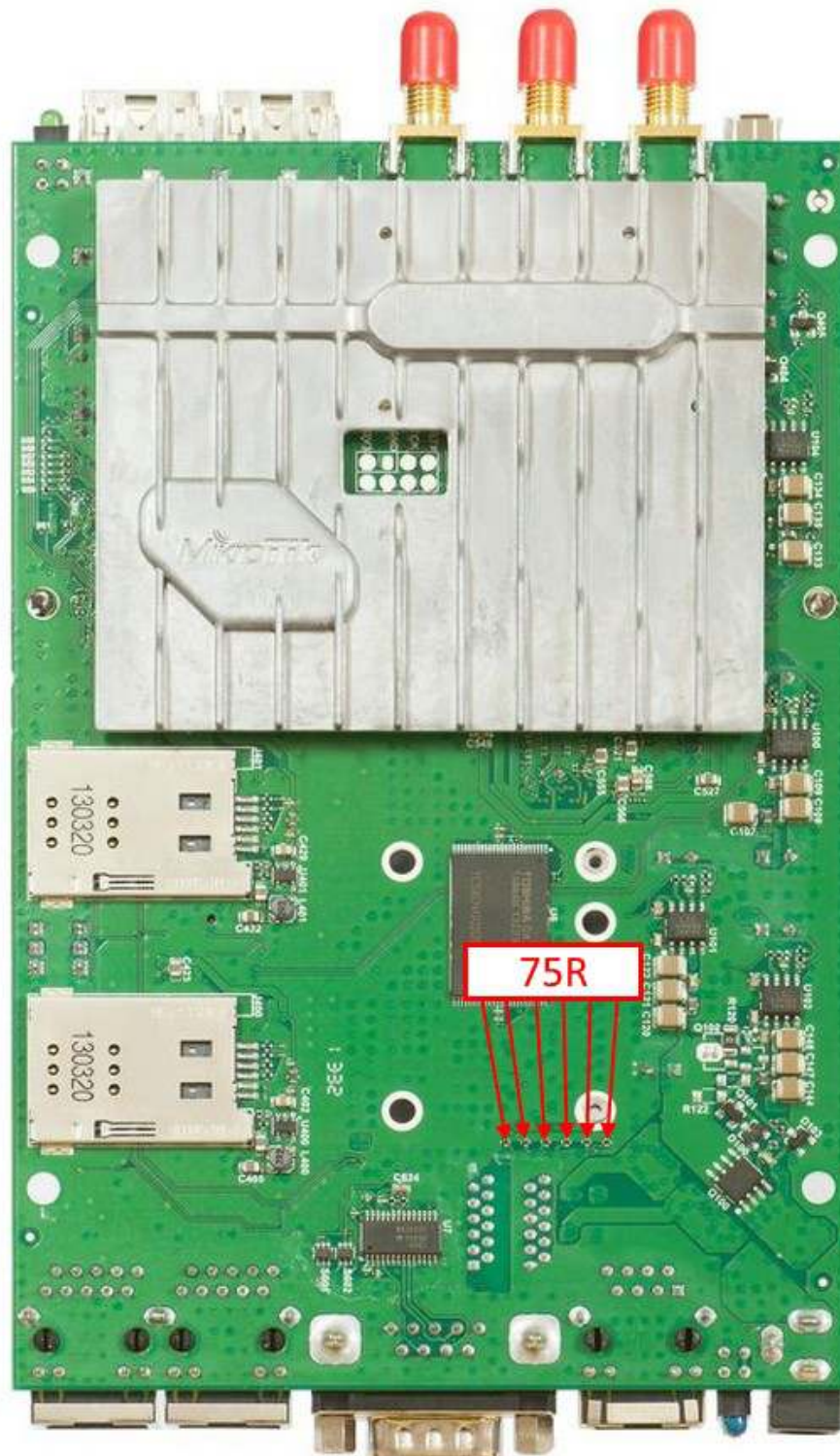

On ports Ether2 – Ether3 You can take patch cord and plug it into the routerboard, and then measure resistance of termination resistors.

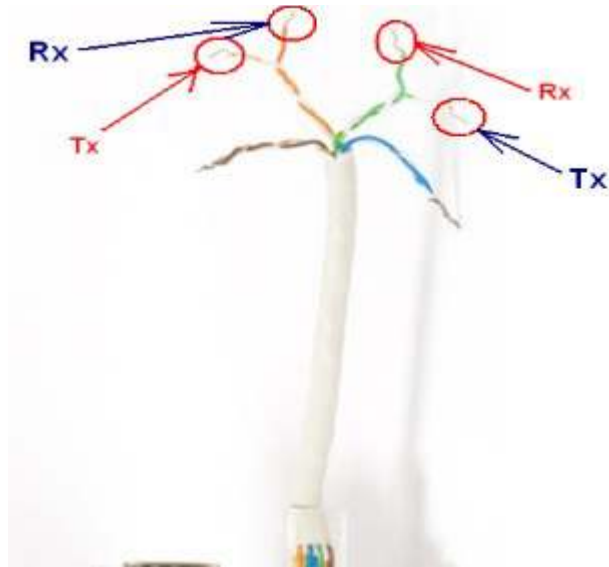

Resistance value between Rx and Tx line must be 150 Ohm $\pm 4\%$.

If resistance value is smaller or higher then Tx/Rx line was damaged by high voltage surge.

RB850Gx2 series RouterBoards

RB850Gx2

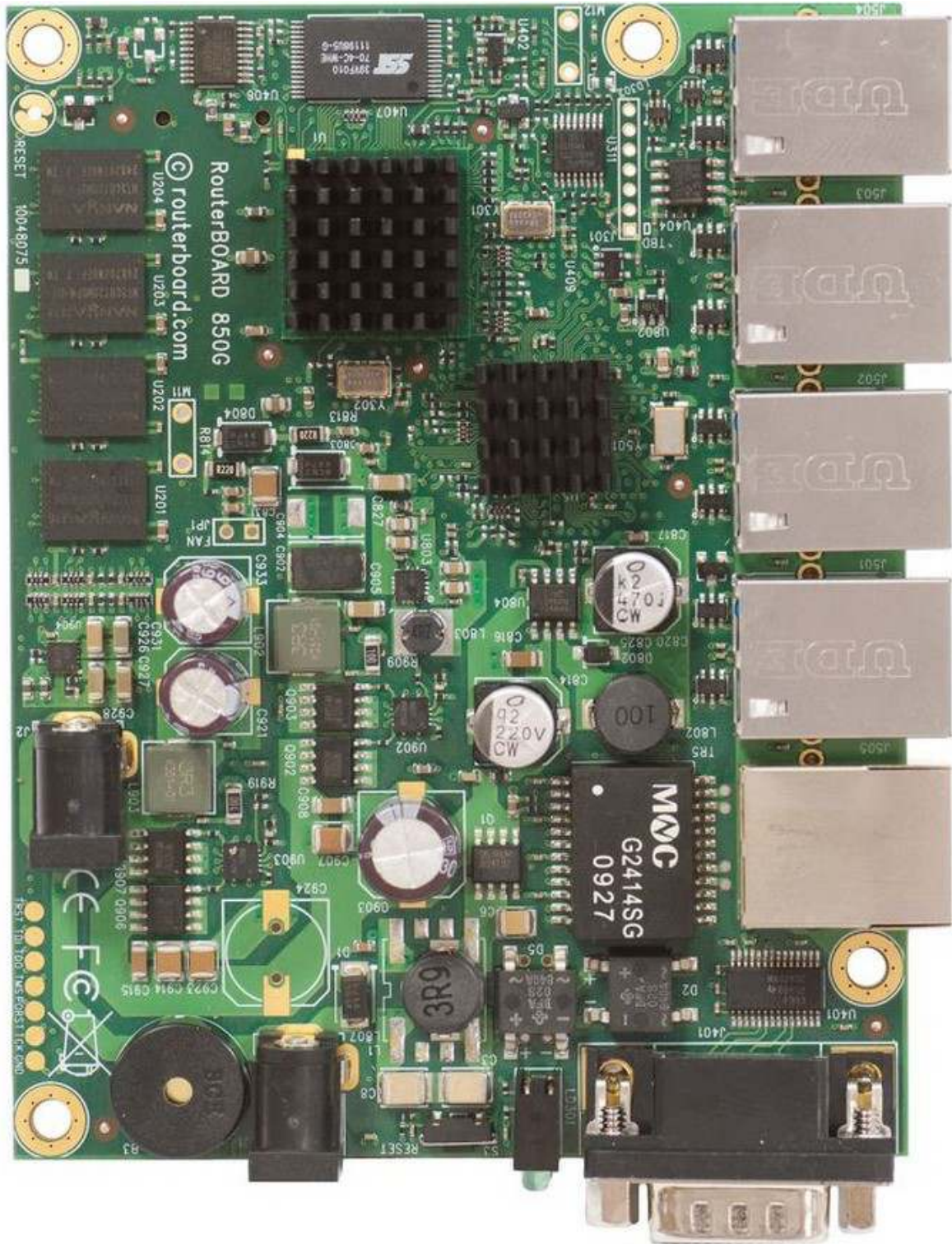

Schottky diode measuring with multimeter in diode mode

Schottky diode reference number is D1; Voltage drop value should be about 0,225V

Diode bridge reference numbers are D2 and D5. Voltage drop value should be about 0,675V

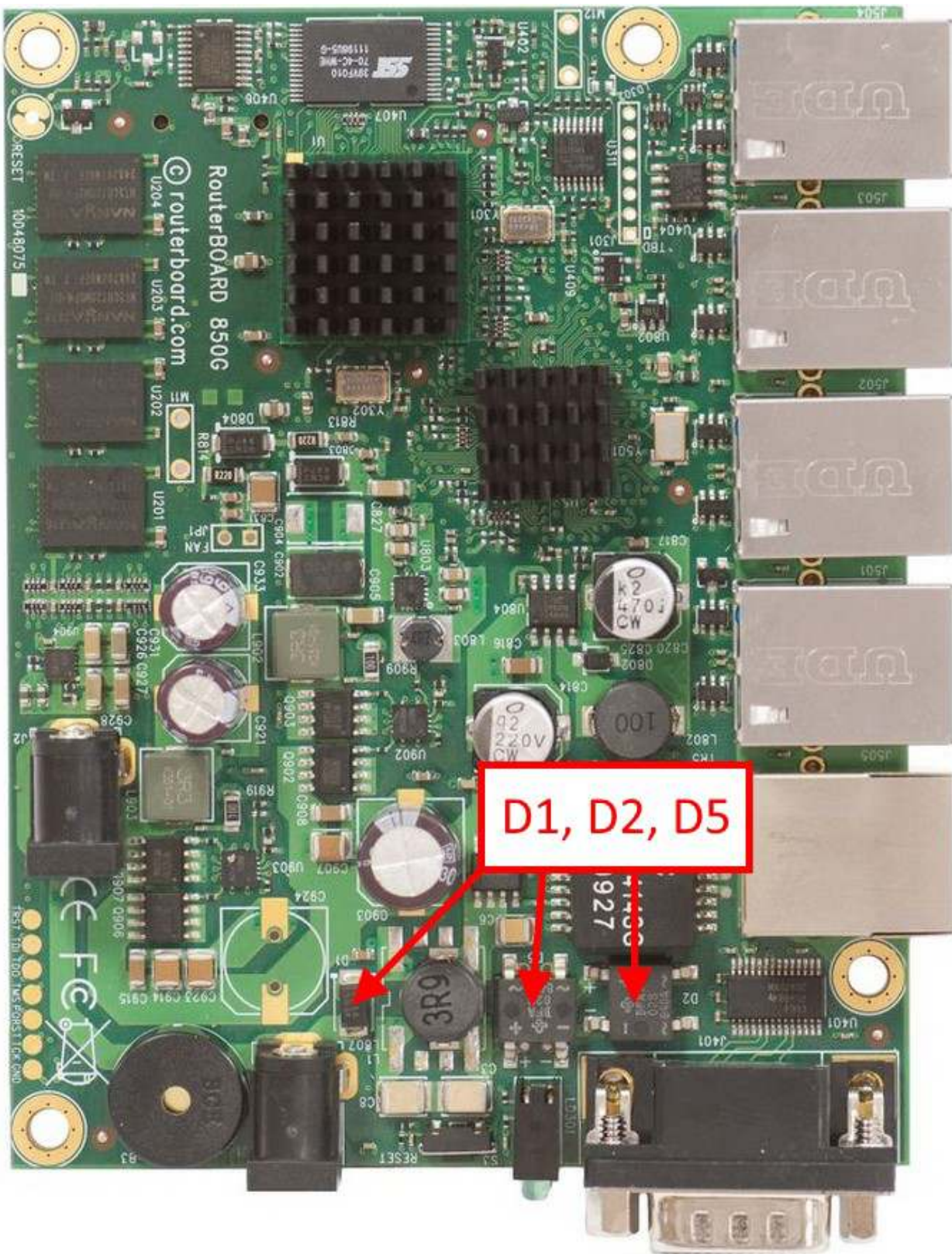

Voltage drop between diode array pin#1 and Ground.

Check voltage drop between TR5, ether2- ether5 Transformers pins and Ground. Ether Pins are marked with red arrows and circles.

It should be in the range from 0,32V to 0,589V

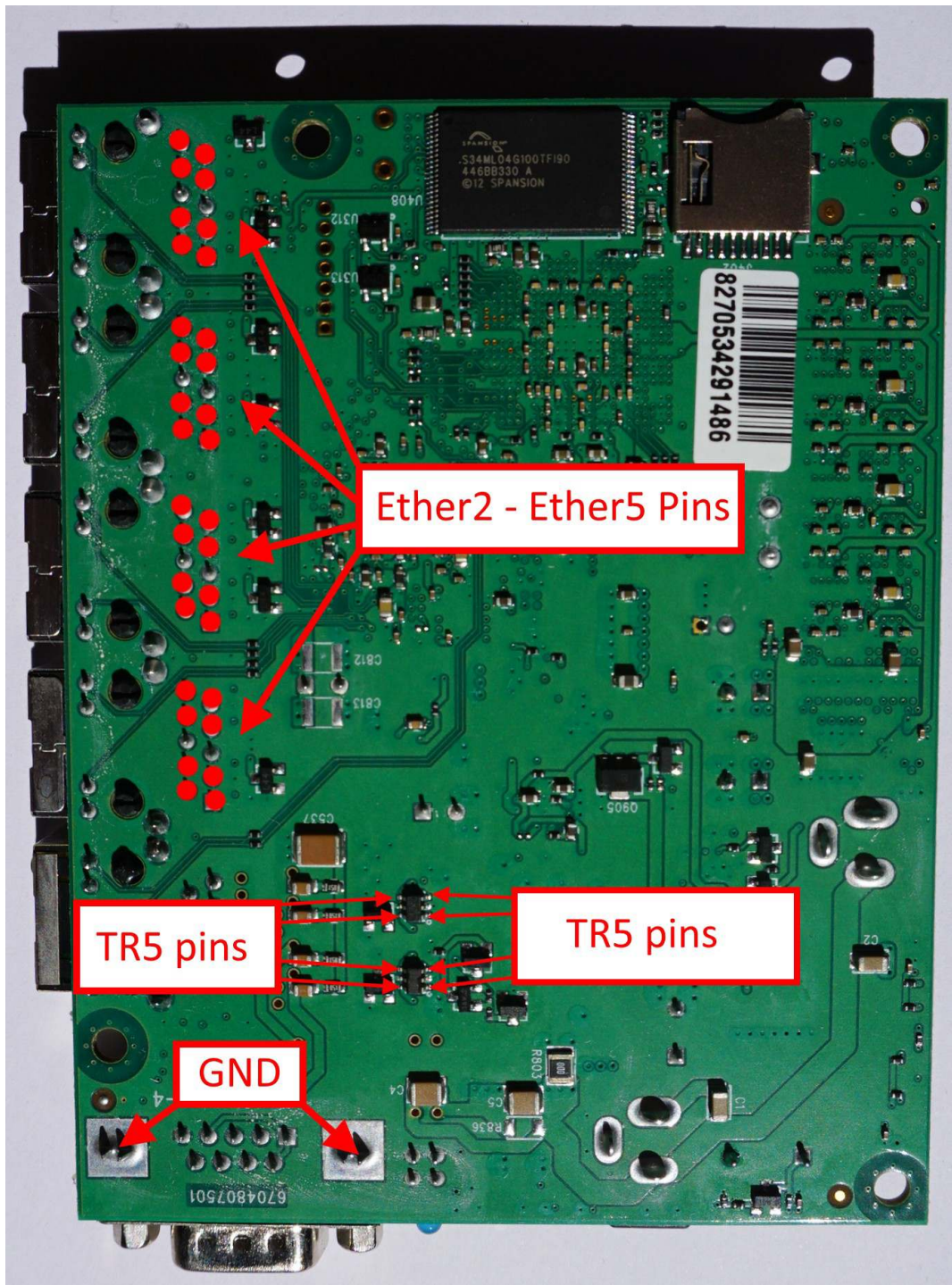

75R Termination resistors resistance.

Resistor resistance, marked with red arrow, should be 75 Ohm +/- 1%

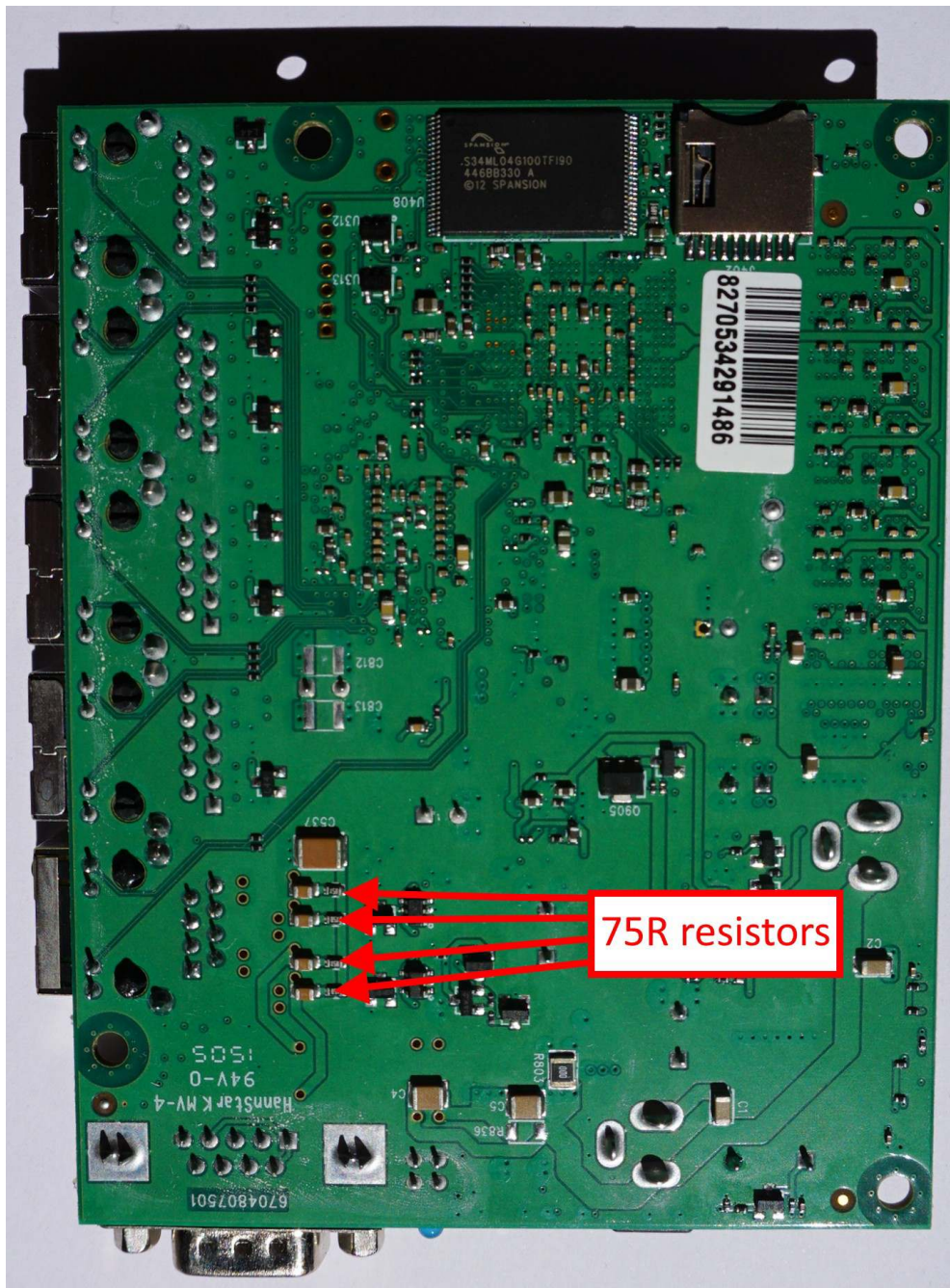

On ports Ether2 – Ether5 You can take patch cord and plug it into the routerboard, and then measure resistance of termination resistors.

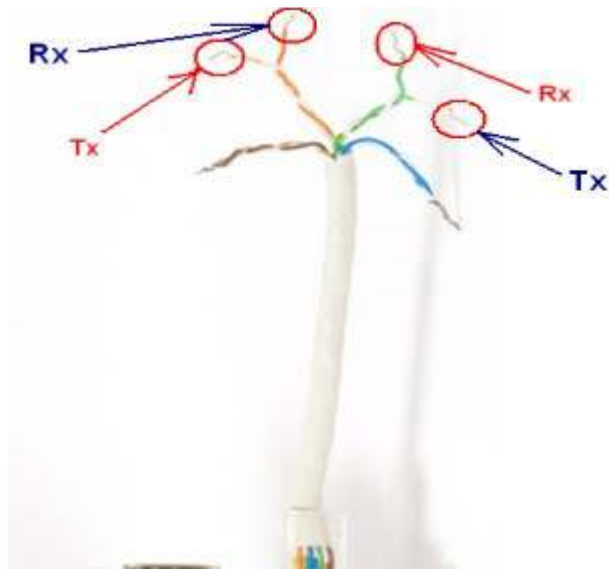

Resistance value between Rx and Tx line must be 150 Ohm $\pm 4\%$.

If resistance value is smaller or higher then Tx/Rx line was damaged by high voltage surge.

RB912G - 2HnD series RouterBoards

RB912UAG-2HPnD

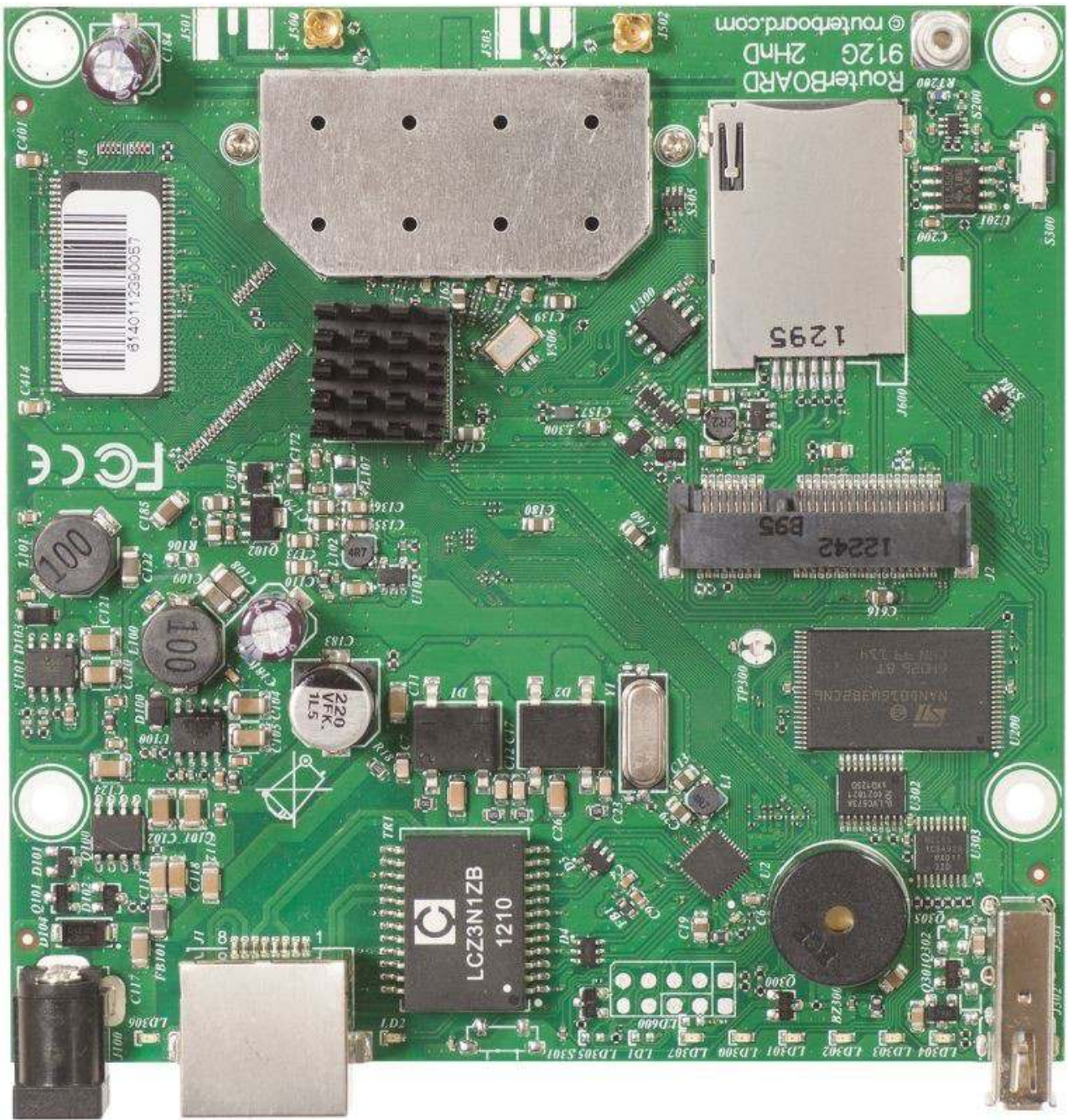

RB911G-2HPnD

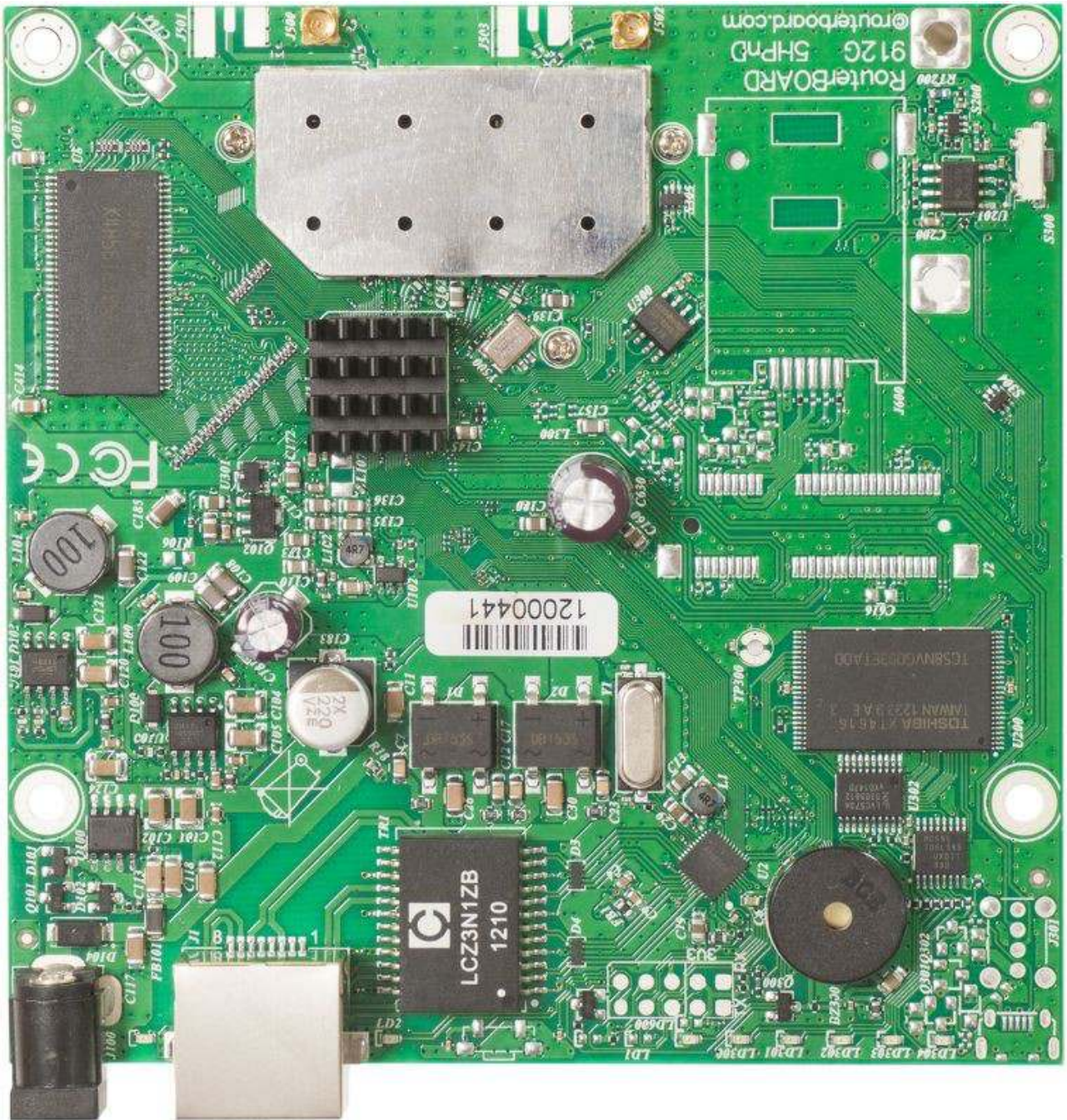

BaseBox 2



BaseBox 2 disassembling information

1. step

Remove the sticker from connectors



2. step

Remove the screw stickers



3. step

Unscrew the case base from the board holder with torque screwdriver T8



4. step

Remove the case base from the board holder

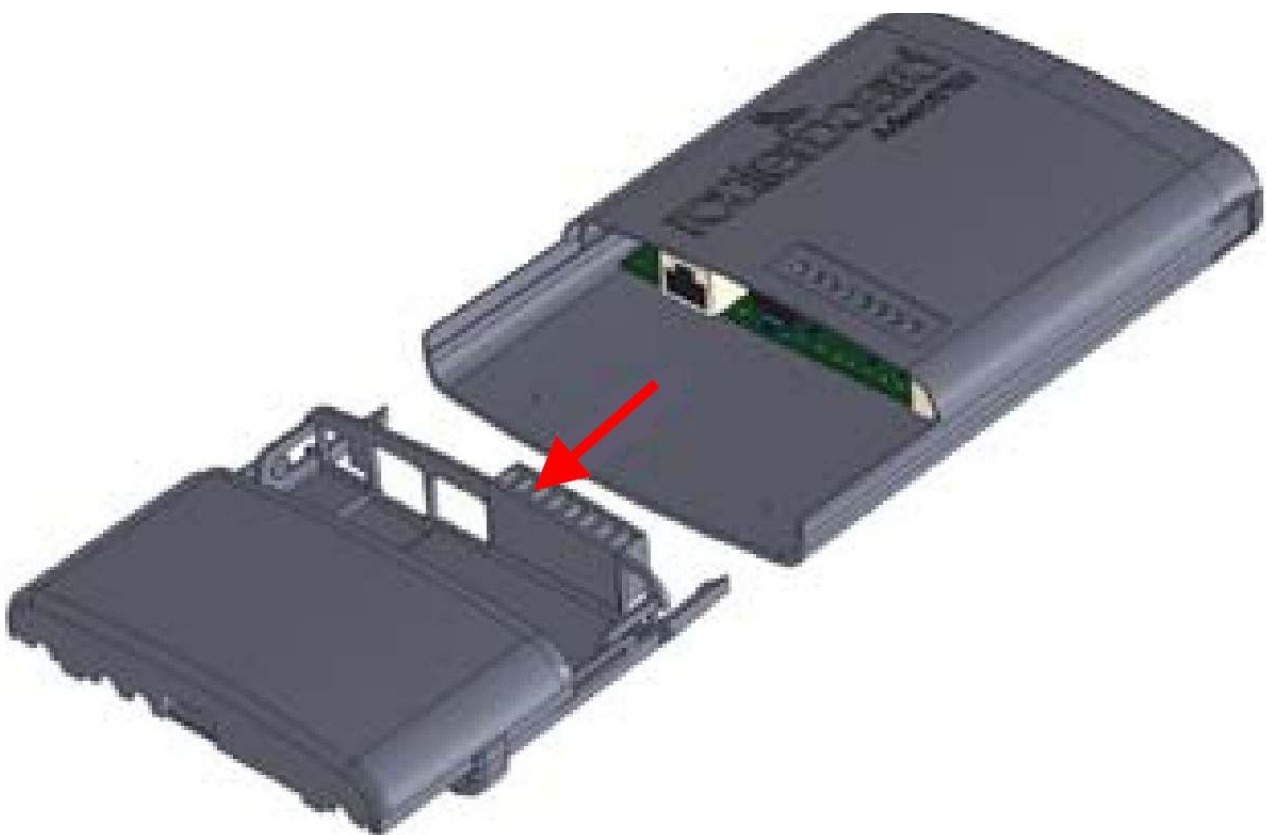

Schottky diode measuring with multimeter in diode mode

Schottky diode reference number is D104; Voltage drop value should be about 0,350V

Diode bridge reference numbers are D1 and D2. Voltage drop value should be about 0,563V

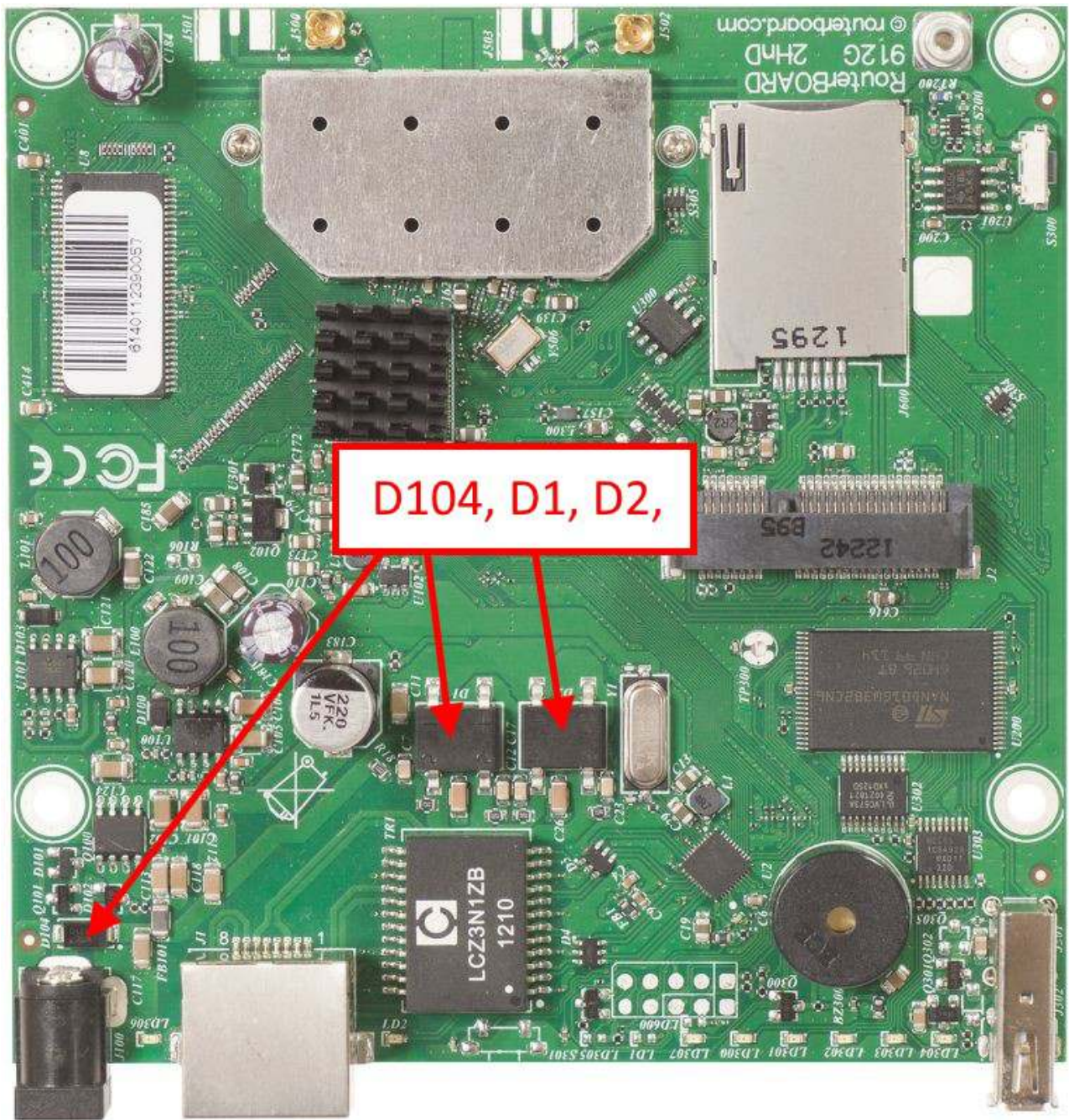

Voltage drop between diode array pin#1 and Ground.

Check voltage drop between TR1, Transformers pins and Ground. Ether Pins are marked with red arrows.

It should be in the range from 0,32V to 0,589V

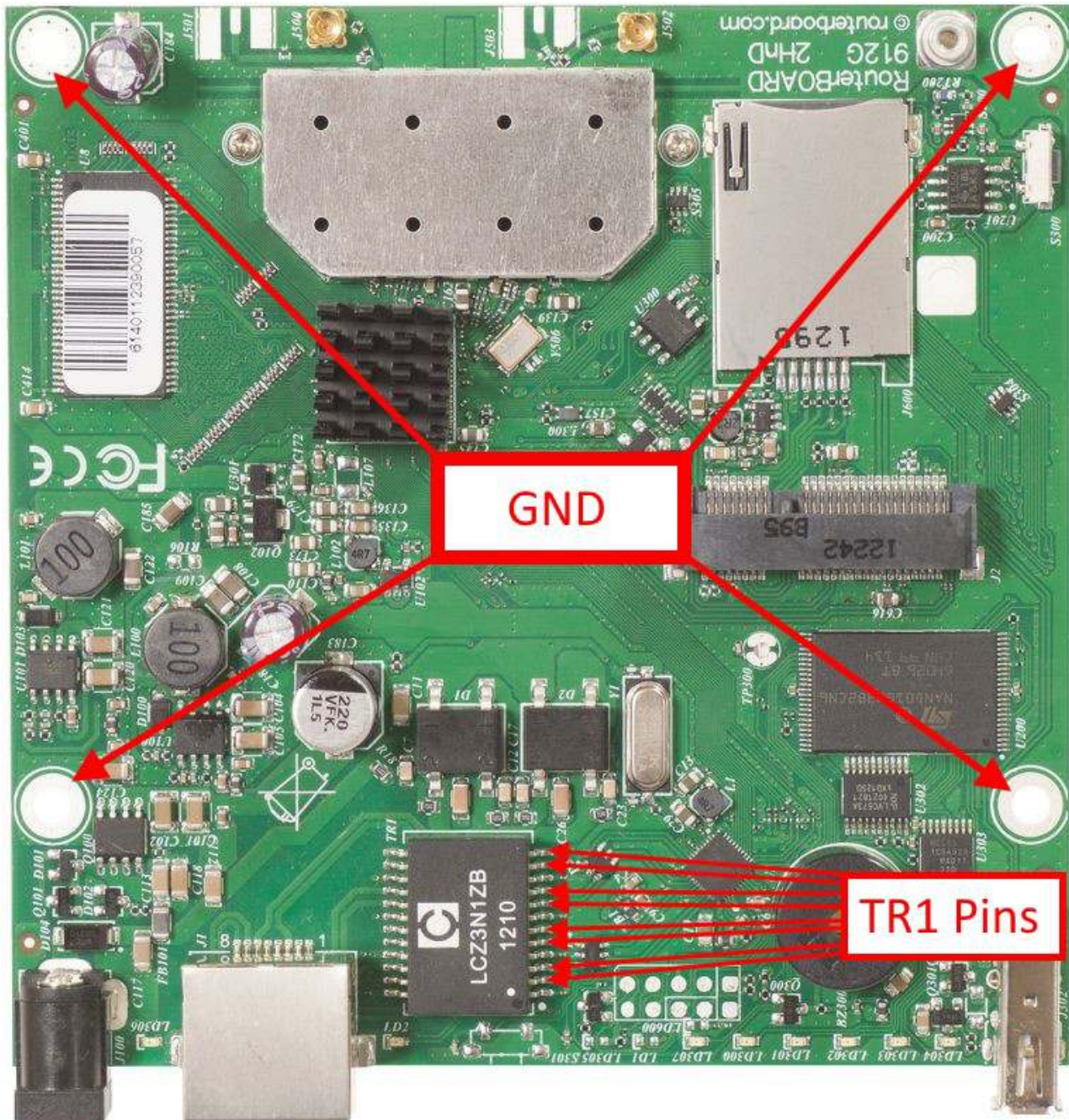

75R Termination resistors resistance.

Resistor resistance, marked with red arrow, should be 75 Ohm +/- 1%

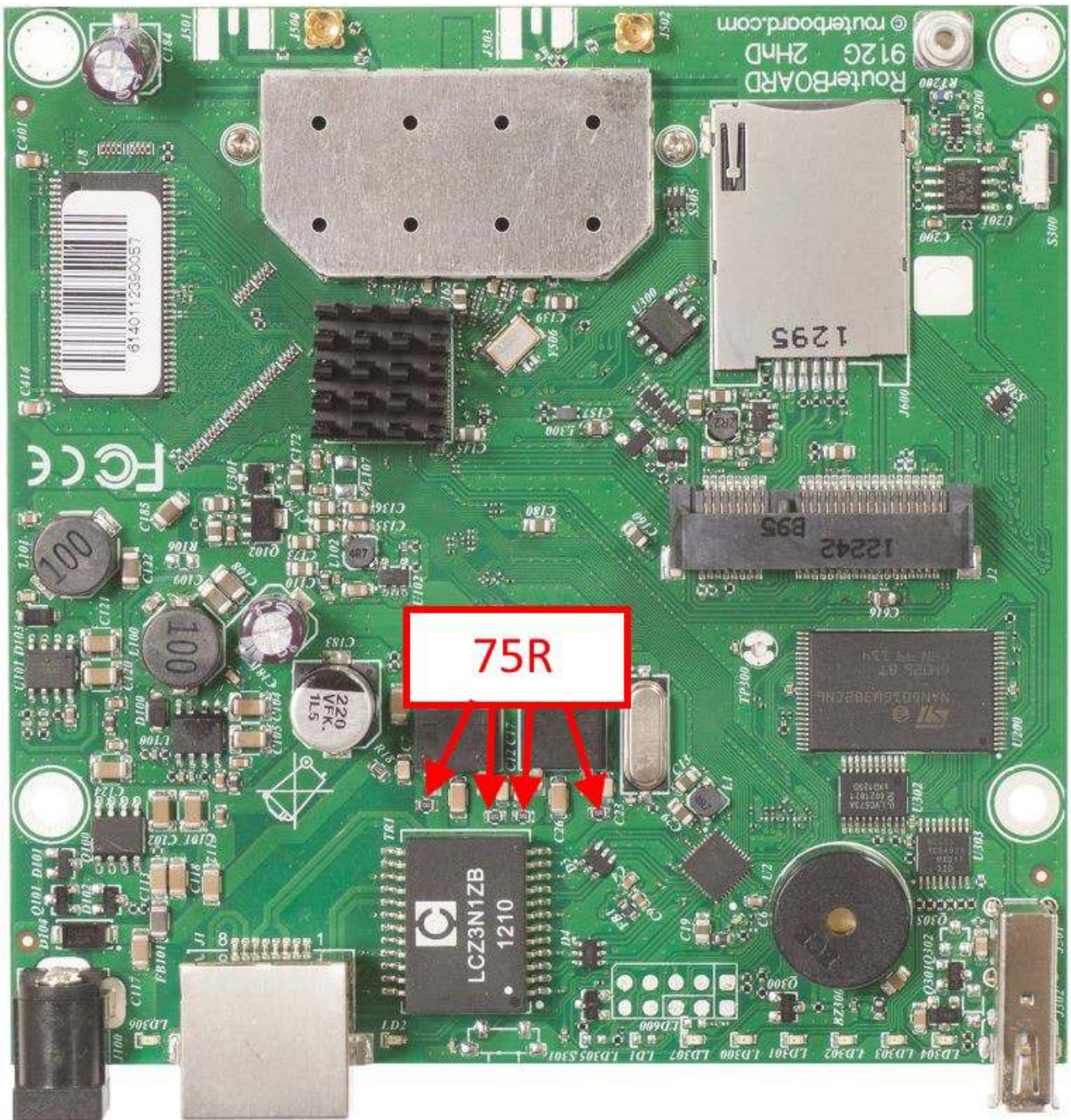

RB912G - 5HPnD series RouterBoards

RB912UAG-5HPnD

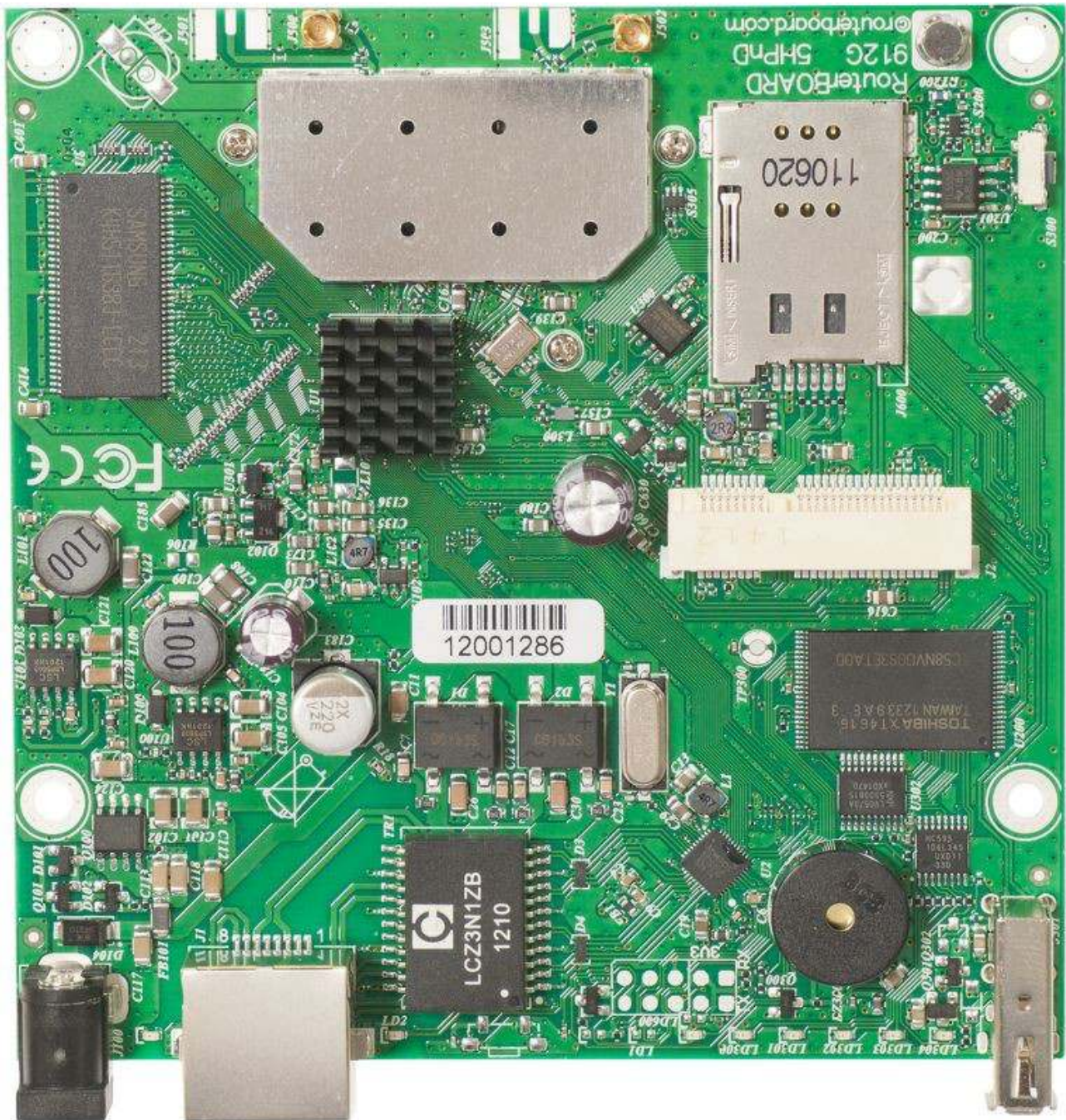

SEXTANT G 5HPnD



BaseBox 5



QRT 5



QRT 5 disassembling information

1. step

Remove the wing nut from Ground M4 screw

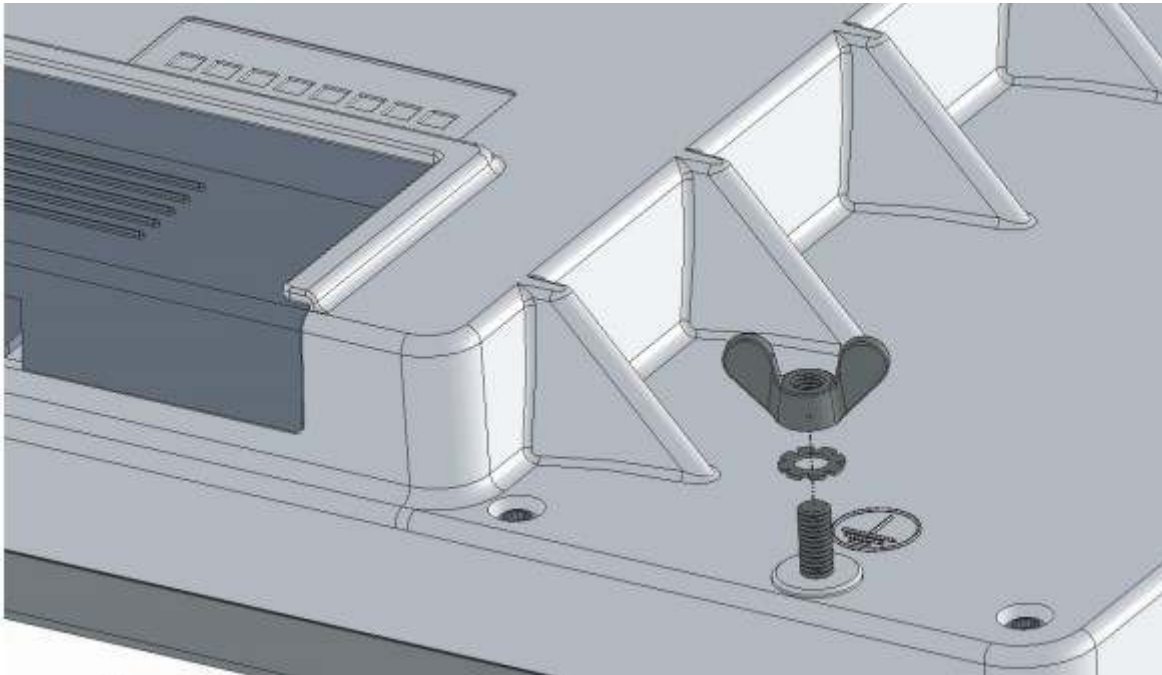

2. step

Remove the 12 pcs screws with torque screwdriver T8

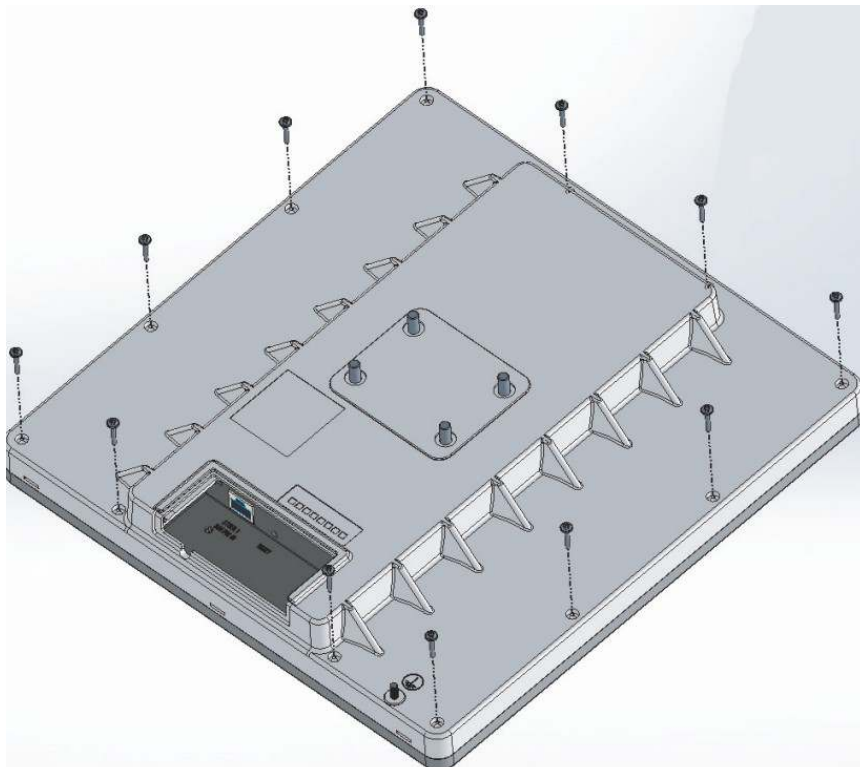

3. step

Remove the cover

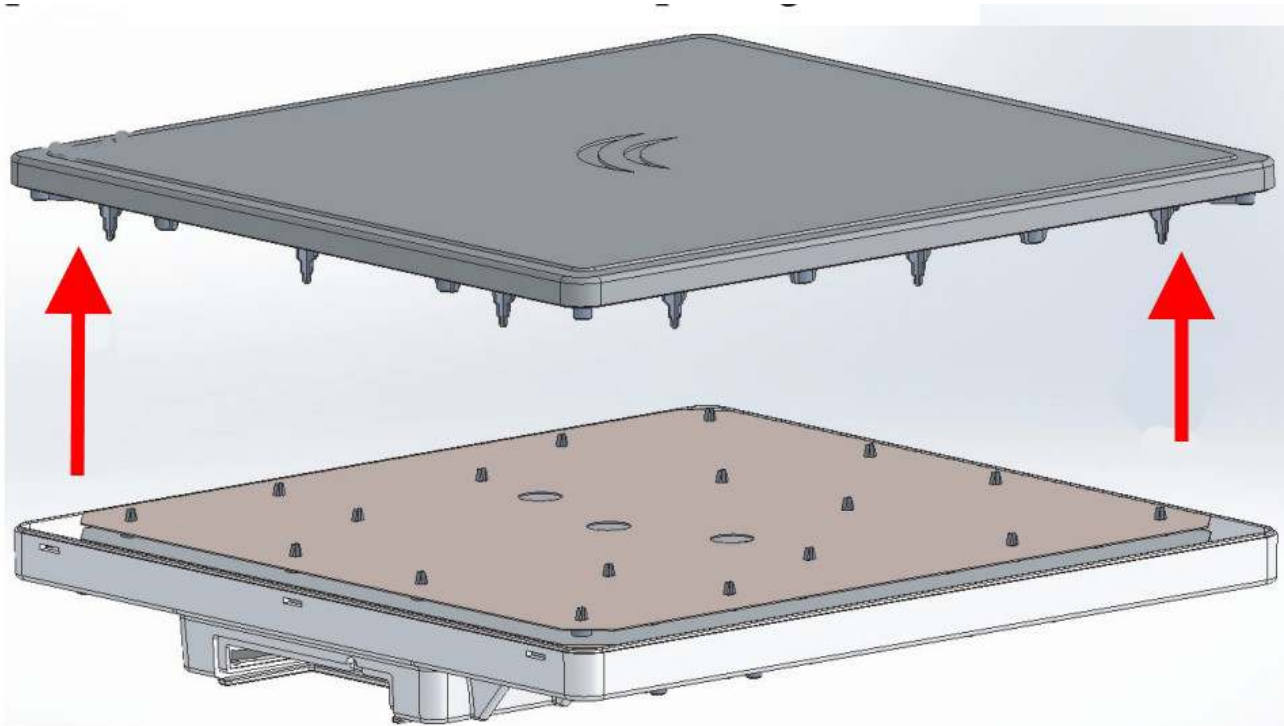

4. step

Remove the M4 screw from bottom plate and than separate bottom plate from antenna with board.

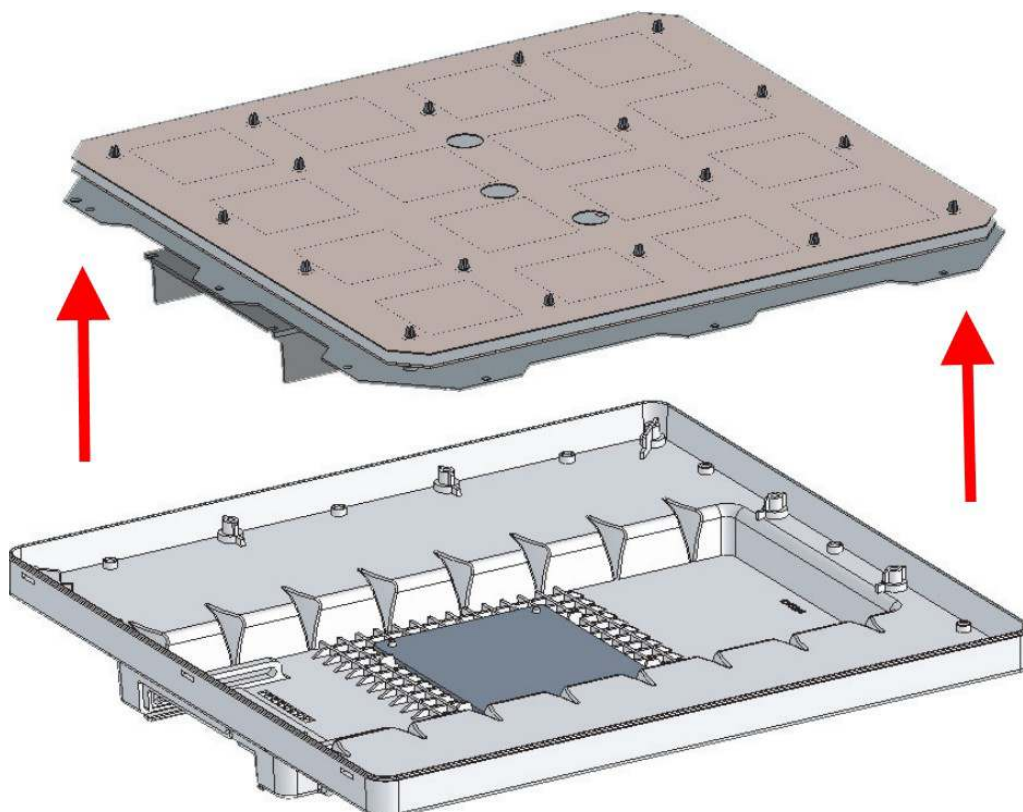

BaseBox 5 disassembling information

1. step

Remove the sticker from connectors



2. step

Remove the screw stickers



3. step

Unscrew the case base from the board holder with torque screwdriver T8



4. step

Remove the case base from the board holder



Schottky diode measuring with multimeter in diode mode

Schottky diode reference number is D104; Voltage drop value should be about 0,350V

Diode bridge reference numbers are D1 and D2. Voltage drop value should be about 0,563V

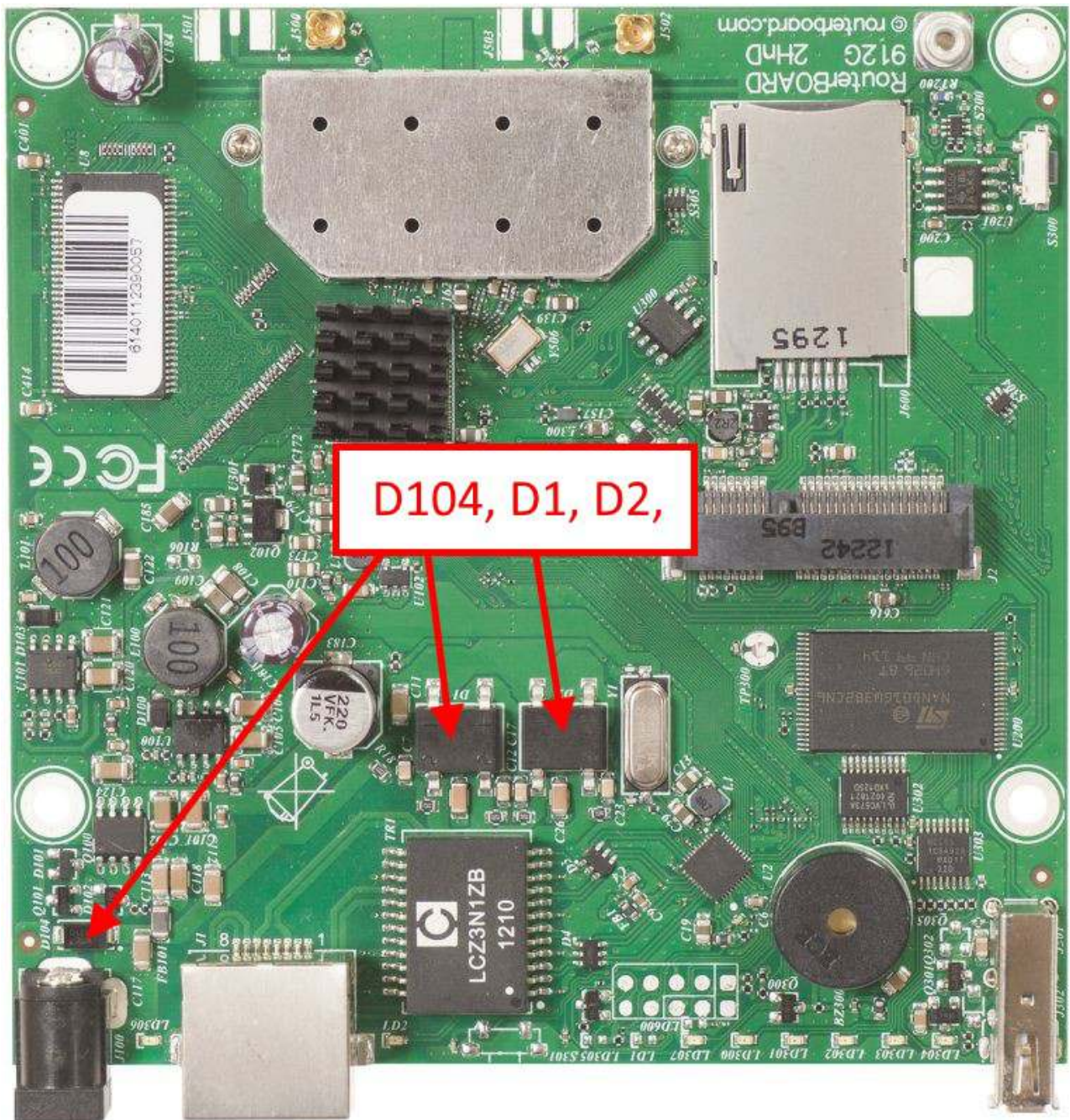

Voltage drop between diode array pin#1 and Ground.

Check voltage drop between TR1, Transformers pins and Ground. Ether Pins are marked with red arrows.

It should be in the range from 0,32V to 0,589V

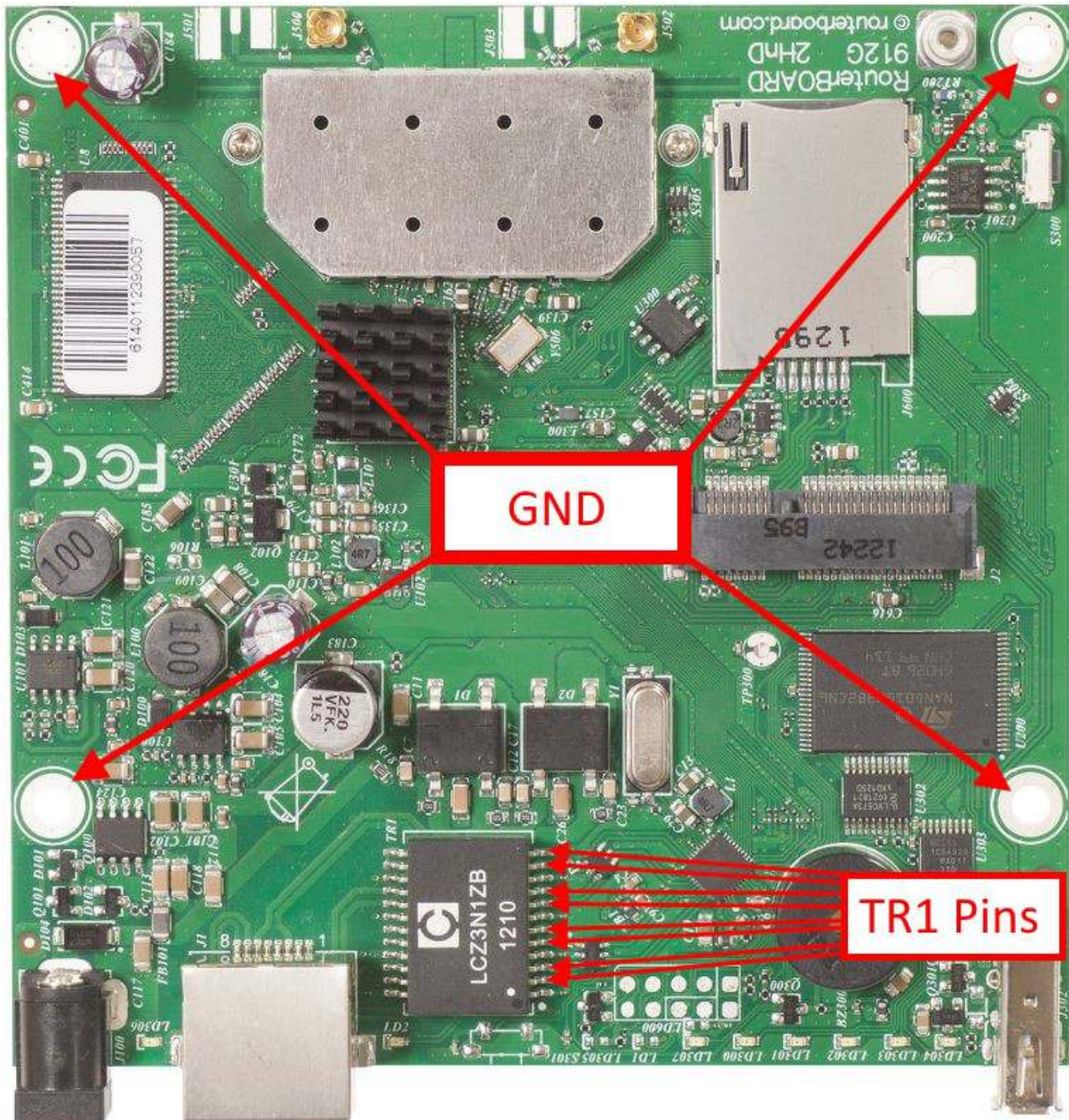

75R Termination resistors resistance.

Resistor resistance, marked with red arrow, should be 75 Ohm +/- 1%

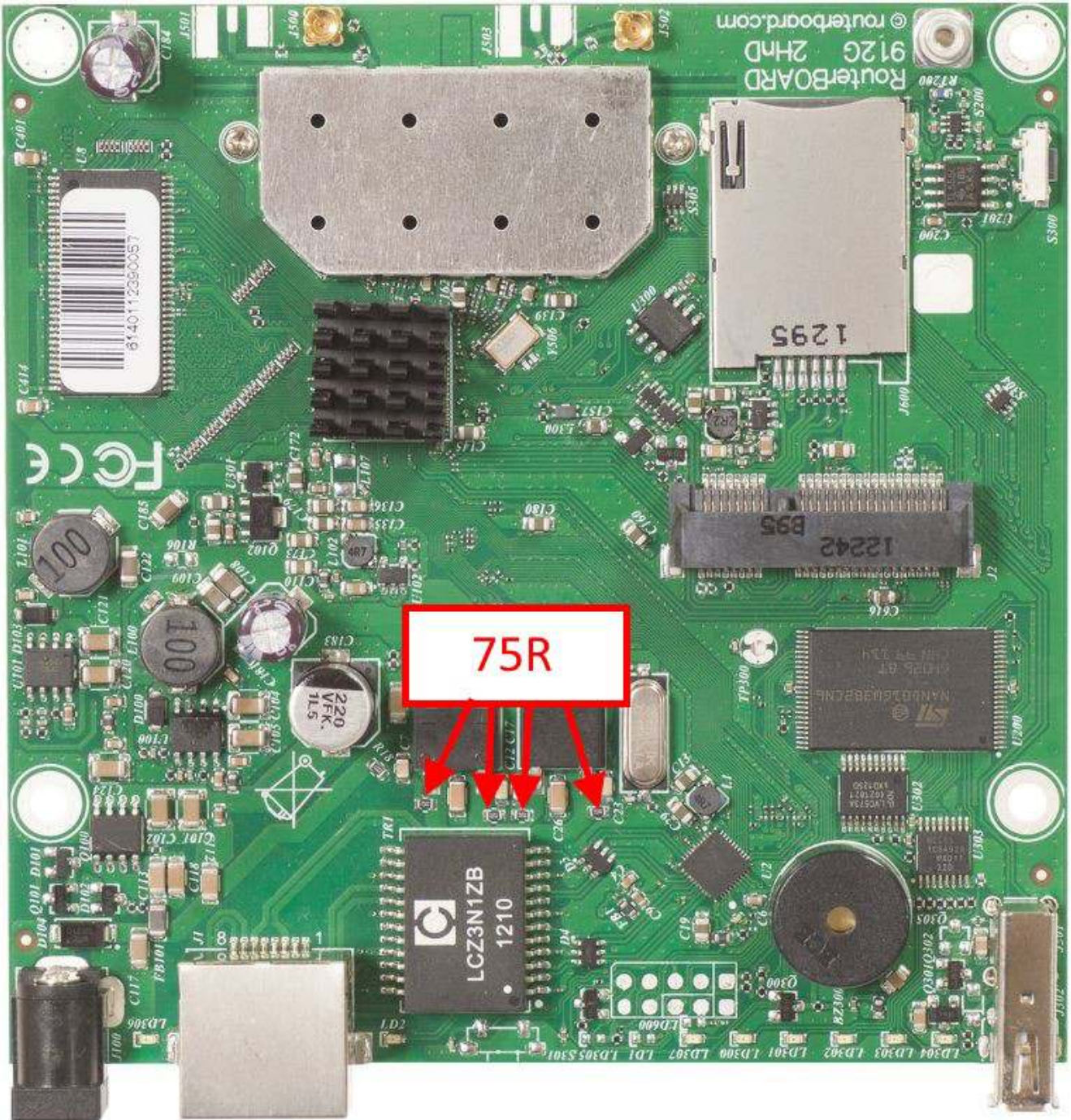

RBSXTG-5HPacD series RouterBoards

RBSXTG-5HPacD series:

SXT 5 ac

SXT SA5 ac



SXT HG5 ac



Disassembling information

SXT series disassembling

1. step

Use two “-” screwdrivers. Push screwdrivers in case cavities.

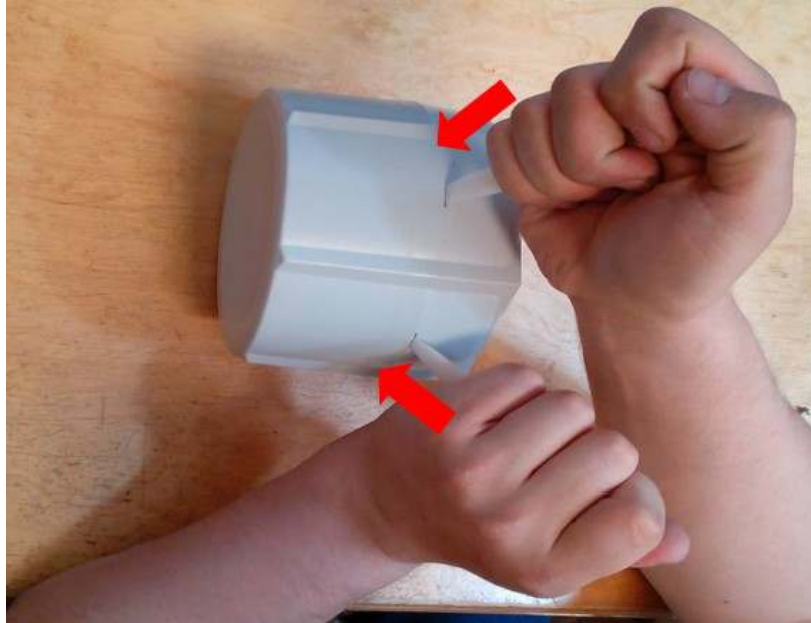

2. step

Rotate screwdriver and pull both case parts.



3. step

Remove rubber bushing

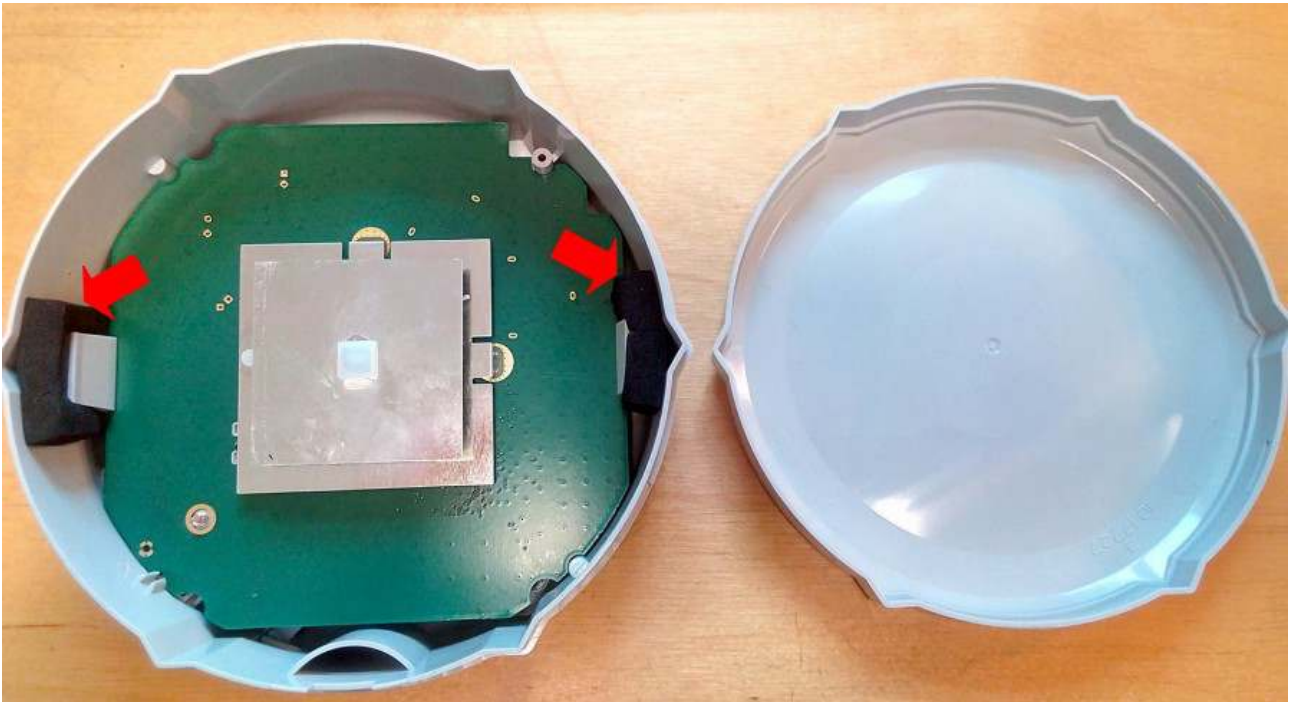

4. step

Push back Plastic PCB holders and take out the board.

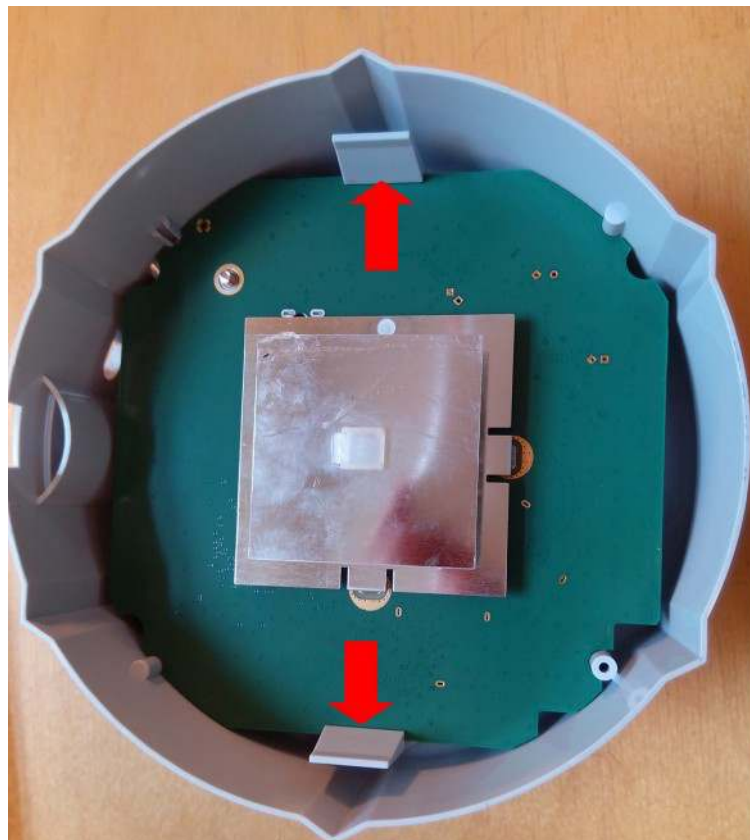

Schottky diode measuring with multimeter in diode mode

Schottky diode reference numbers are D201, D203 . Voltage drop value should be about 0,170V



Voltage drop between diode array pin#1 and Ground.

Check voltage drop between TRF1 Ethernet Transformers pins and Ground. Ether Pins are marked with red arrows.

It should be in the range from 0,32V to 0,48V



RBSXTLite2 series RouterBoards

RBSXTLite2 series:

SXT Lite2



Disassembling information

SXT series disassembling

1. step

Use two “-” screwdrivers. Push screwdrivers in case cavities.

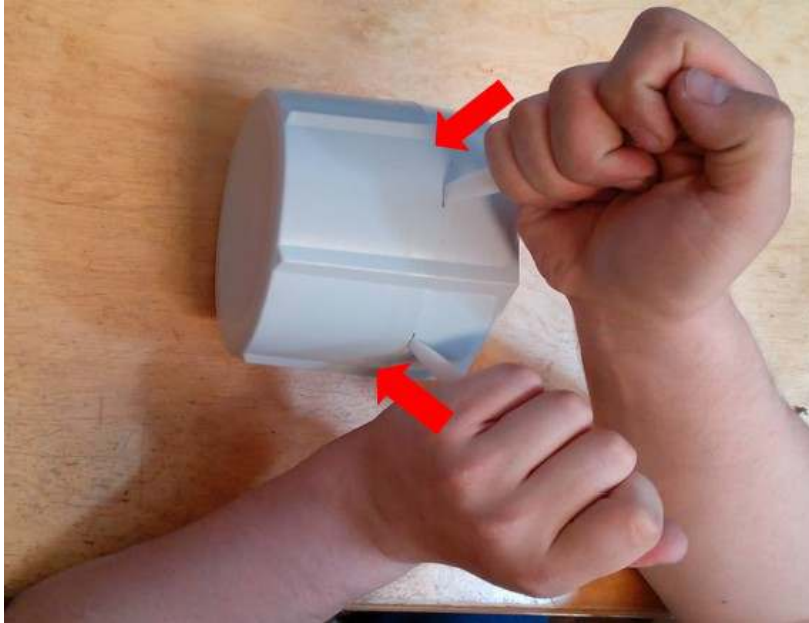

2. step

Rotate screwdriver and pull both case parts.



3. step

Remove rubber bushing

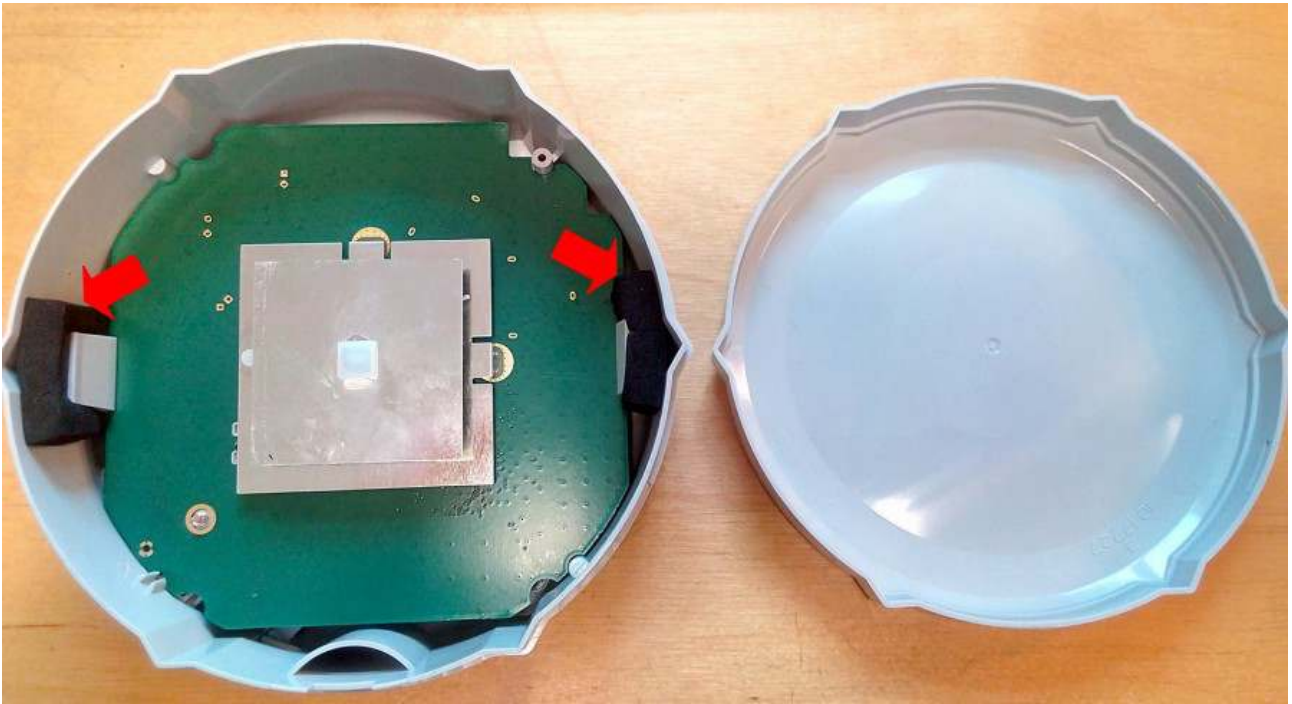

4. step

Push back Plastic PCB holders and take out the board.

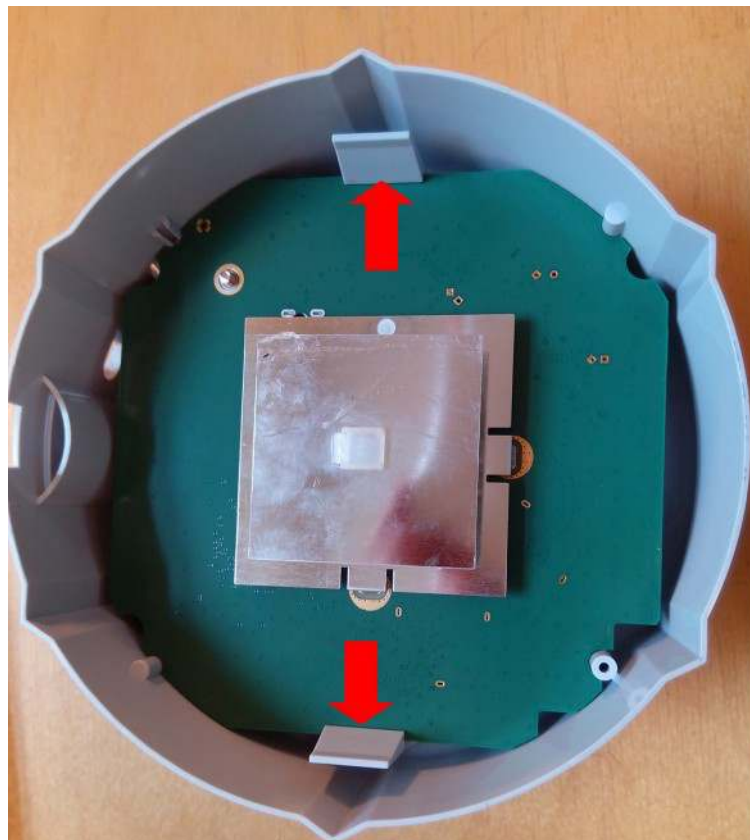

Schottky diode measuring with multimeter in diode mode

Schottky diode reference numbers are D5 . Voltage drop value should be about 0,190V

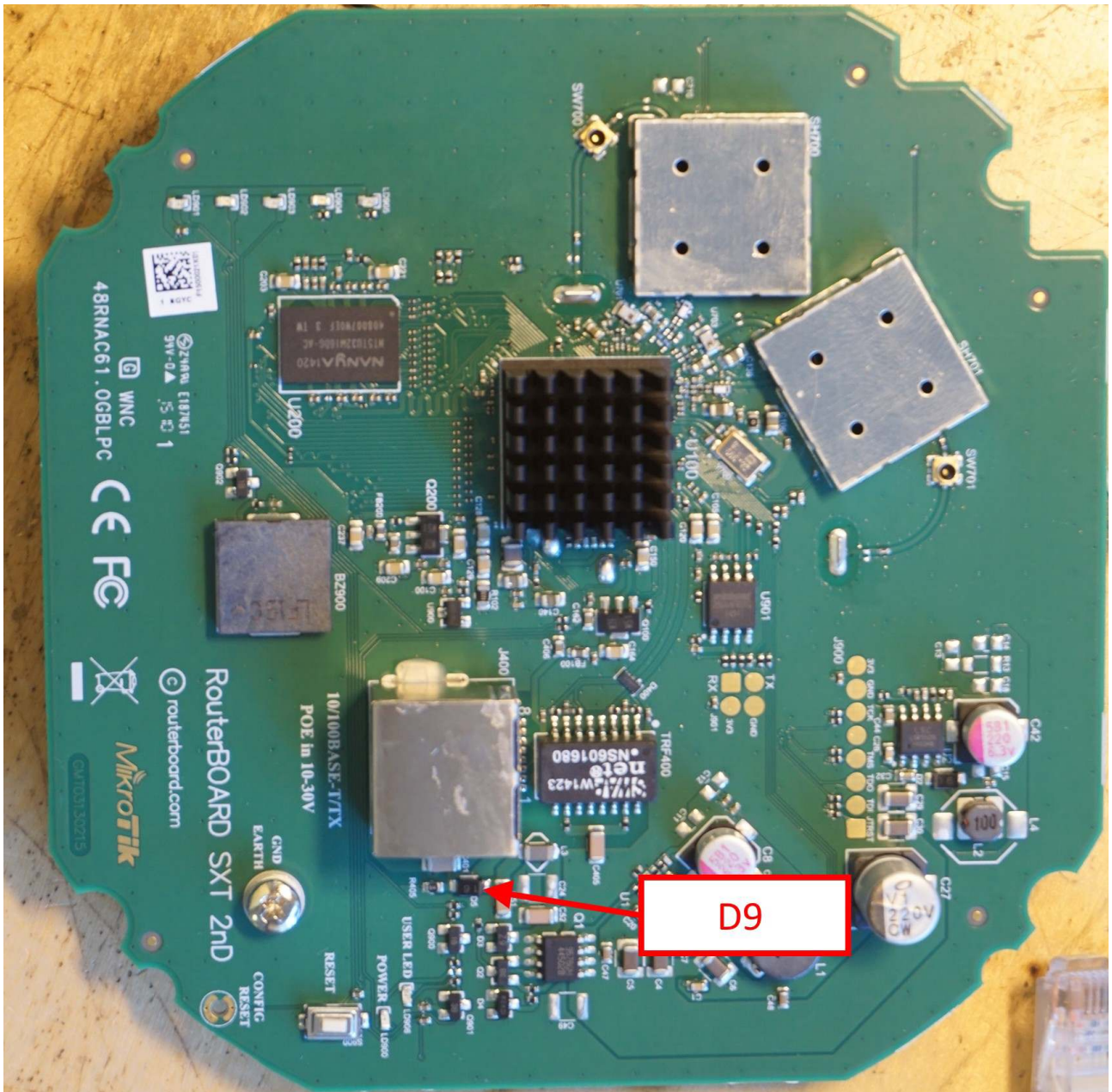

Voltage drop between diode array pin#1 and Ground.

Check voltage drop between TRF400 Ethernet Transformers pins and Ground. Ether Pins are marked with red arrows.

It should be in the range from 0,32V to 0,48V

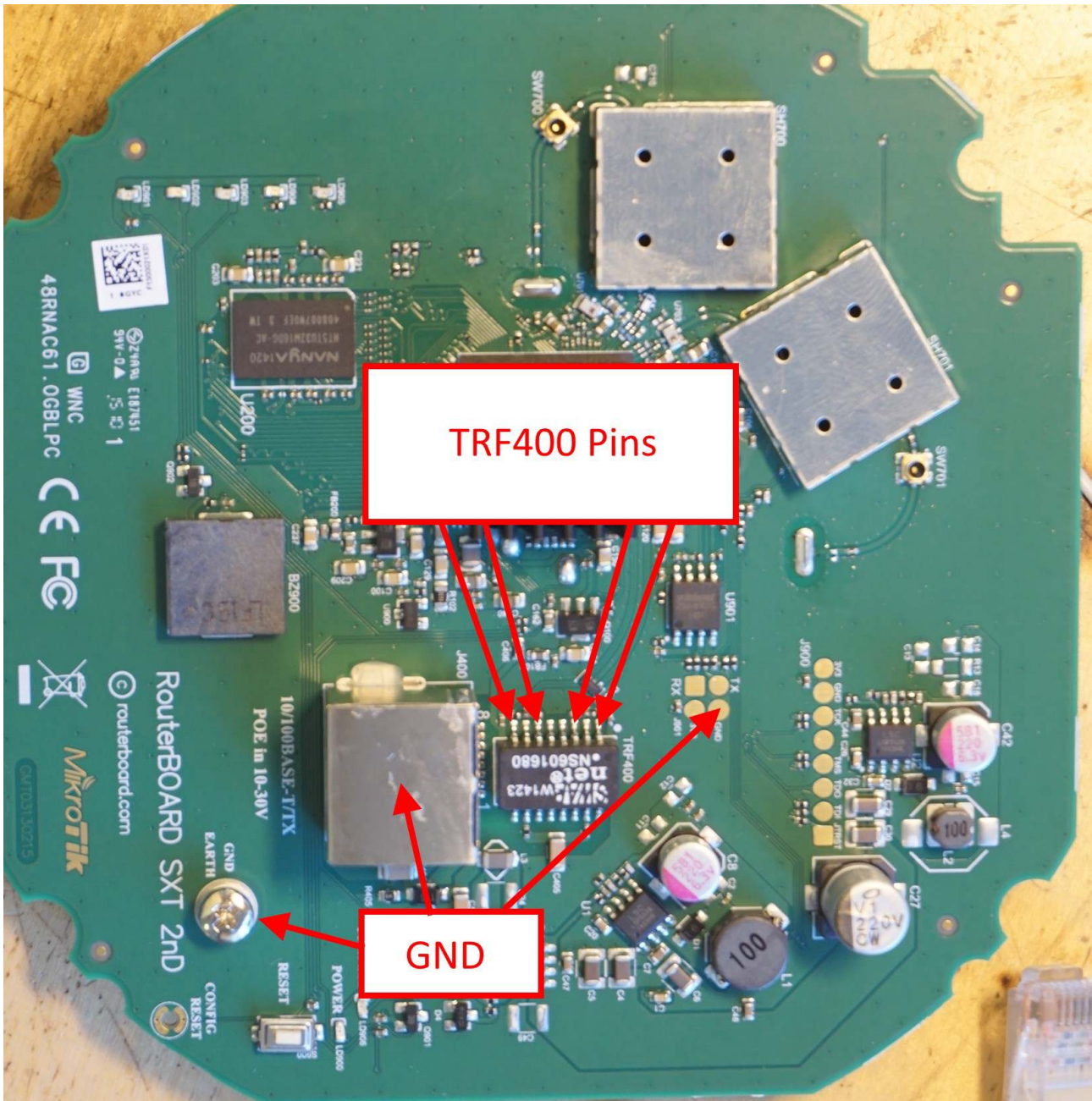

75R Termination resistors resistance.

Resistor resistance, marked with red arrow, should be 75 Ohm +/- 1%

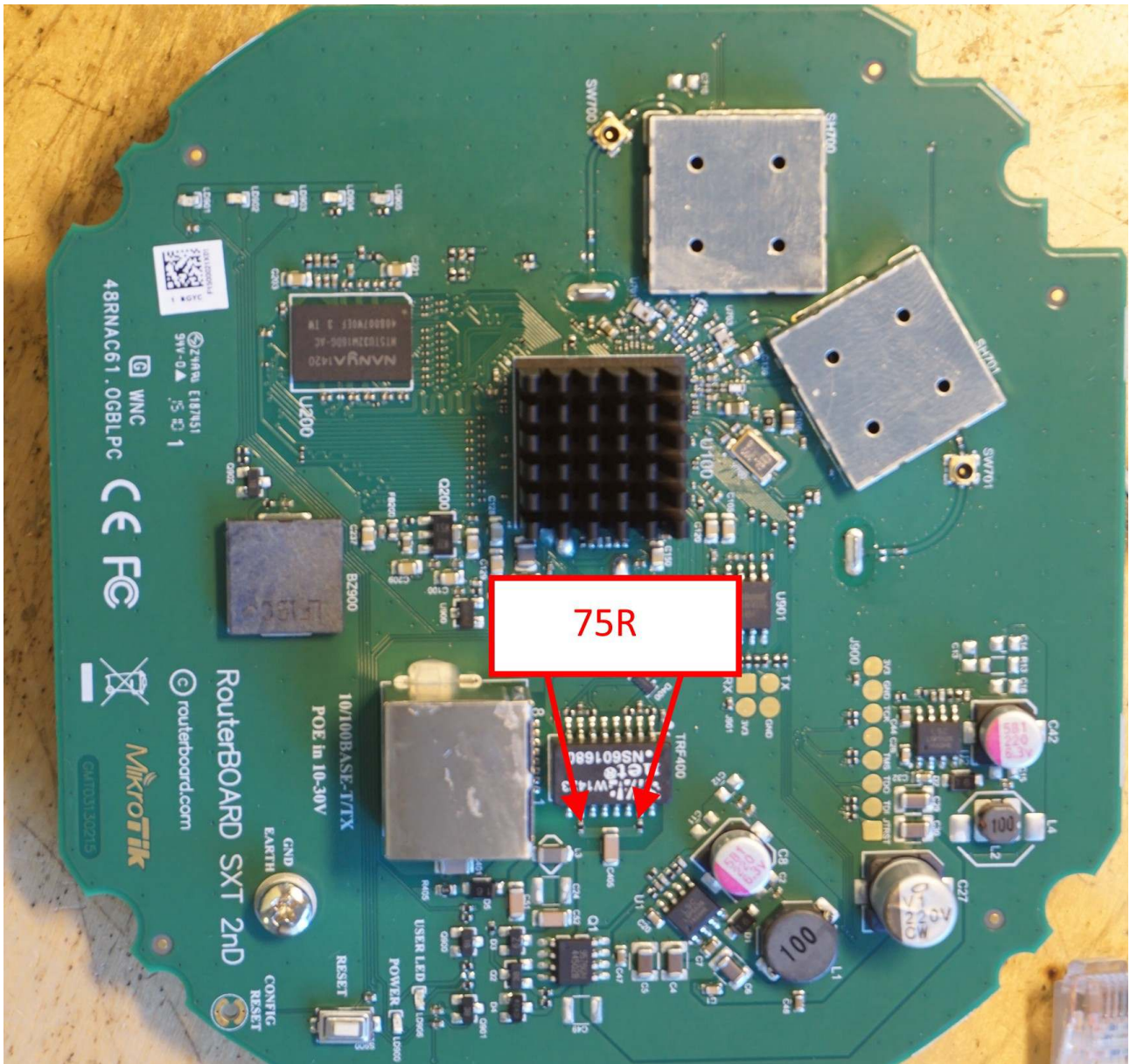

RBSXTLite5 series RouterBoards

RBSXTLite5 series:

SXT Lite5



Disassembling information

SXT series disassembling

1. step

Use two “-” screwdrivers. Push screwdrivers in case cavities.

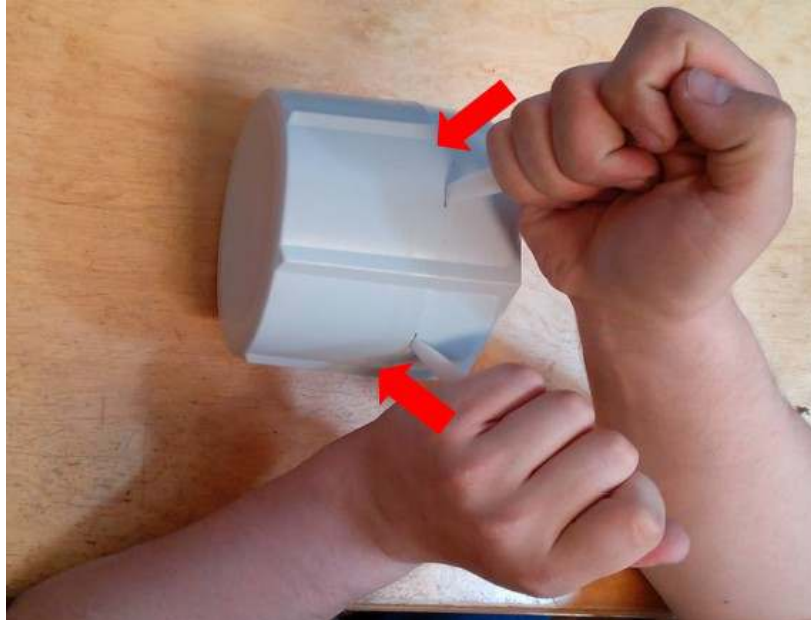

2. step

Rotate screwdriver and pull both case parts.



3. step

Remove rubber bushing

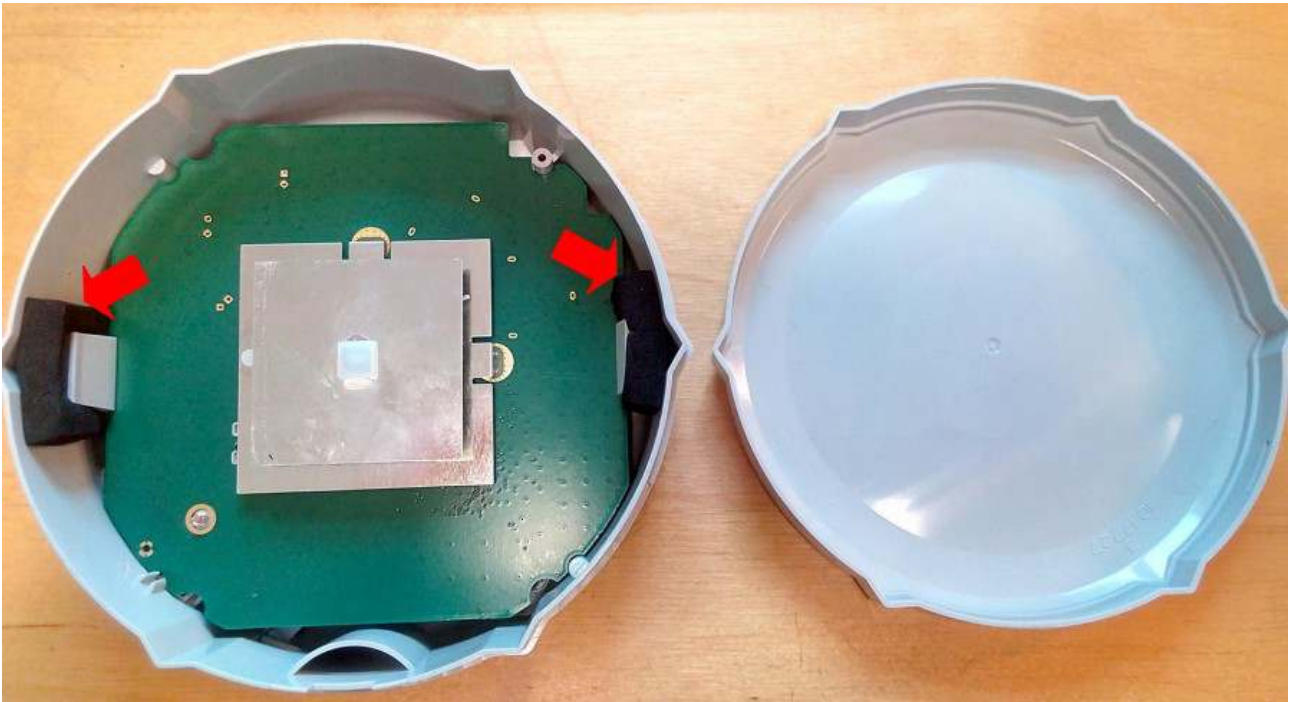

4. step

Push back Plastic PCB holders and take out the board.

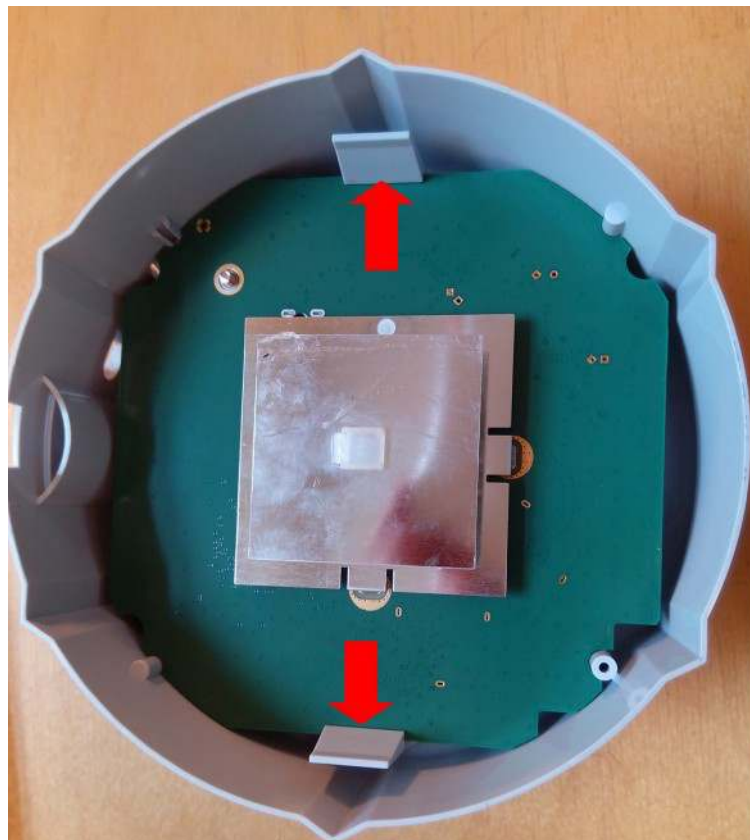

Schottky diode measuring with multimeter in diode mode

Schottky diode reference numbers are D5 . Voltage drop value should be about 0,190V

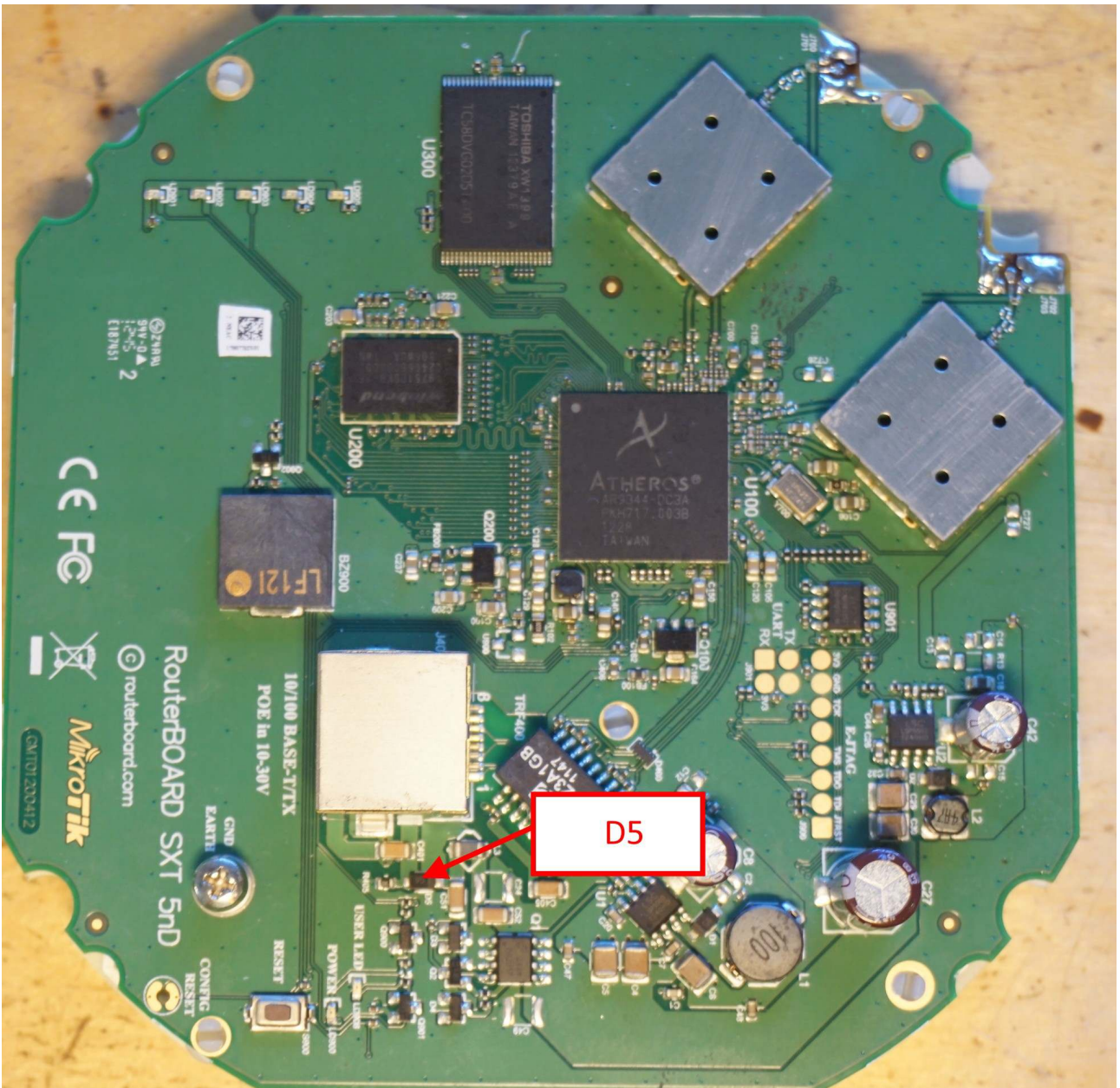

Voltage drop between diode array pin#1 and Ground.

Check voltage drop between TRF400 Ethernet Transformers pins and Ground. Ether Pins are marked with red arrows.

It should be in the range from 0,32V to 0,48V

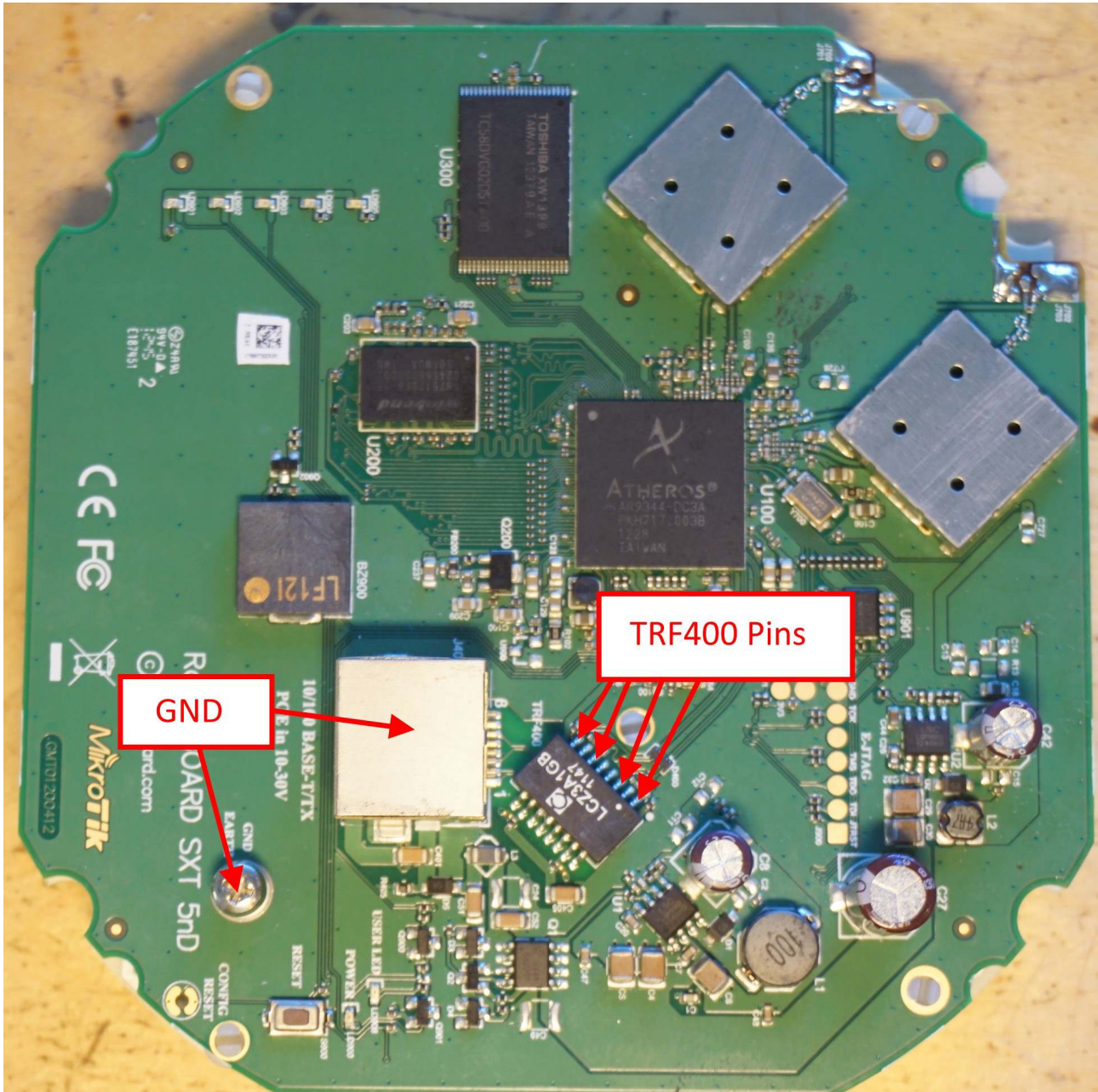

75R Termination resistors resistance.

Resistor resistance, marked with red arrow, should be 75 Ohm +/- 1%

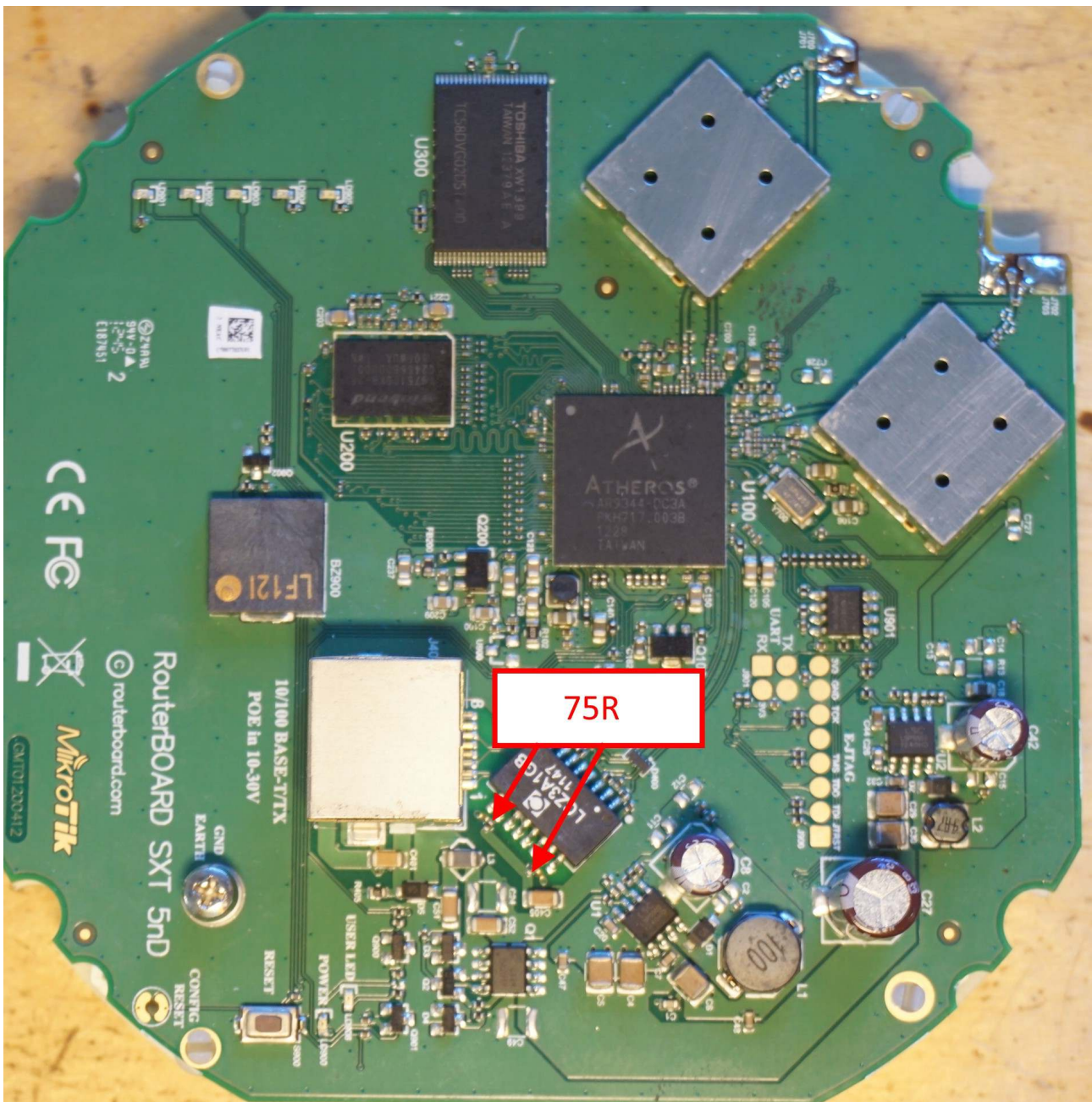

RBSXTG-5HPnD series RouterBoards

RBSXTG-5HPnD series:

SXT HG5



SXT SA5



Disassembling information

SXT series disassembling

1. step

Use two “-” screwdrivers. Push screwdrivers in case cavities.

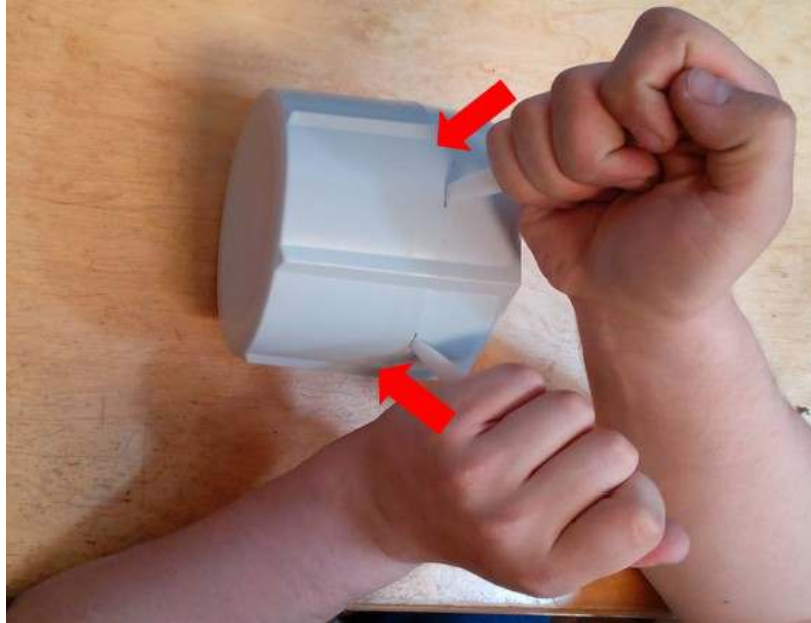

2. step

Rotate screwdriver and pull both case parts.



3. step

Remove rubber bushing

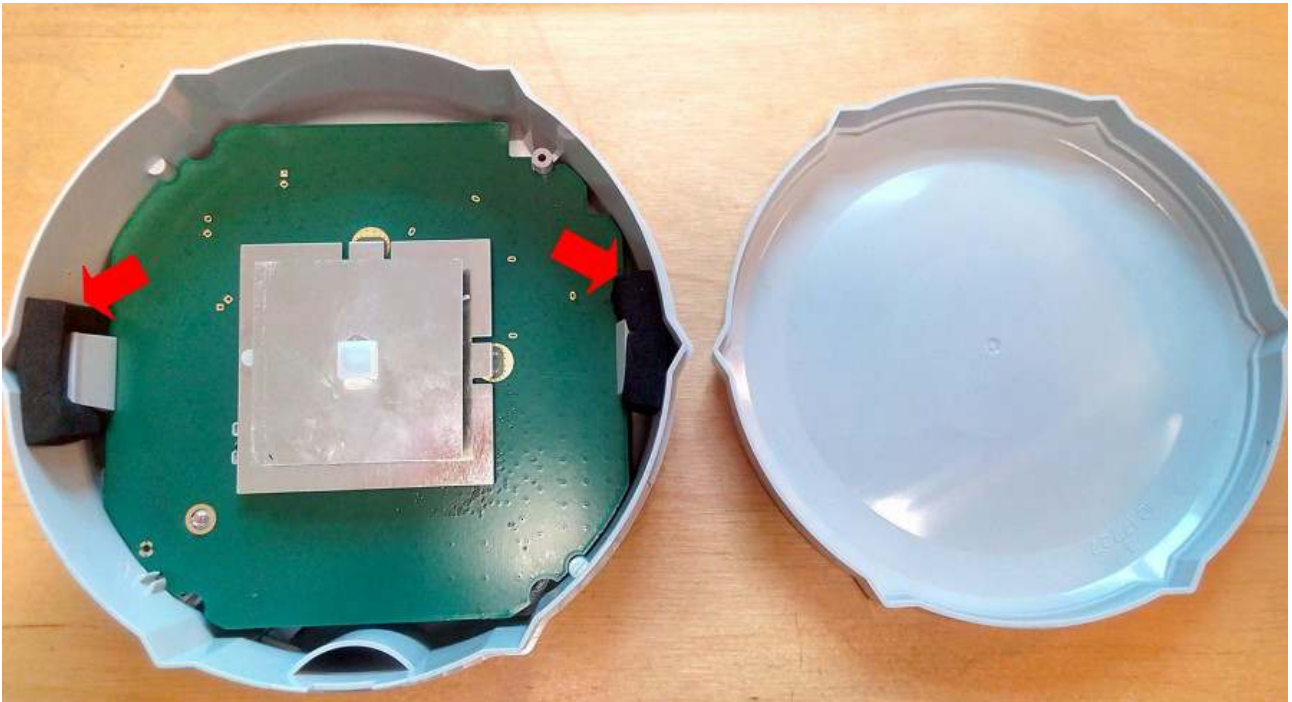

4. step

Push back Plastic PCB holders and take out the board.

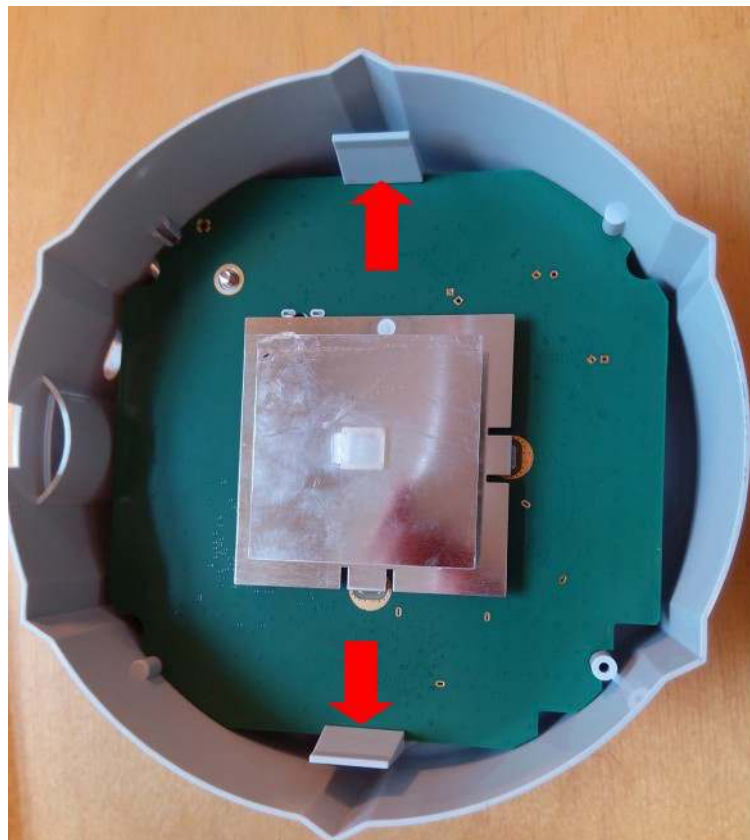

Schottky diode measuring with multimeter in diode mode

Schottky diode reference numbers are D404, D405 . Voltage drop value should be about 0,247V

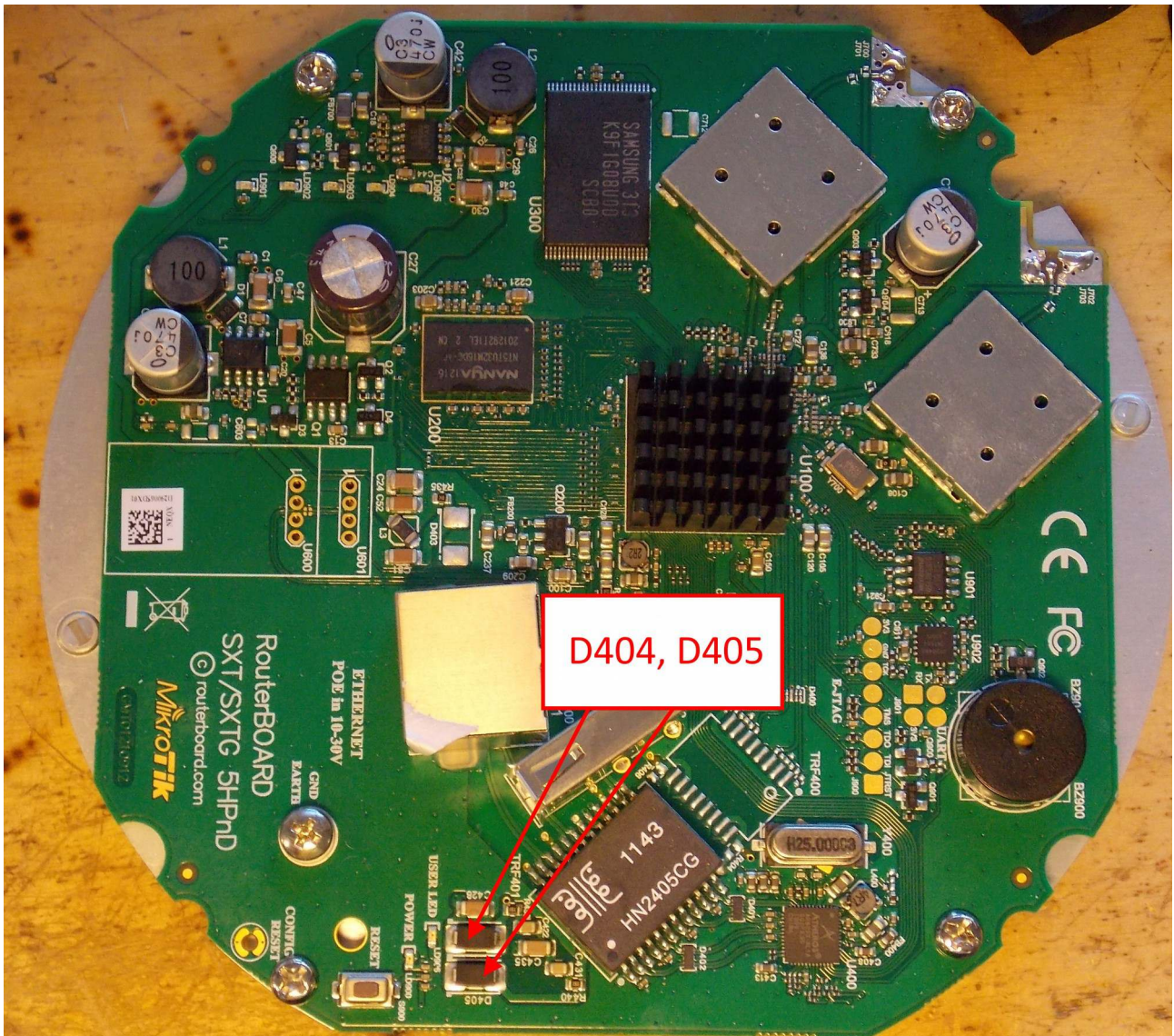

Voltage drop between diode array pin#1 and Ground.

Check voltage drop between TRF401 Ethernet Transformers pins and Ground. Ether Pins are marked with red arrows.

It should be in the range from 0,32V to 0,48V

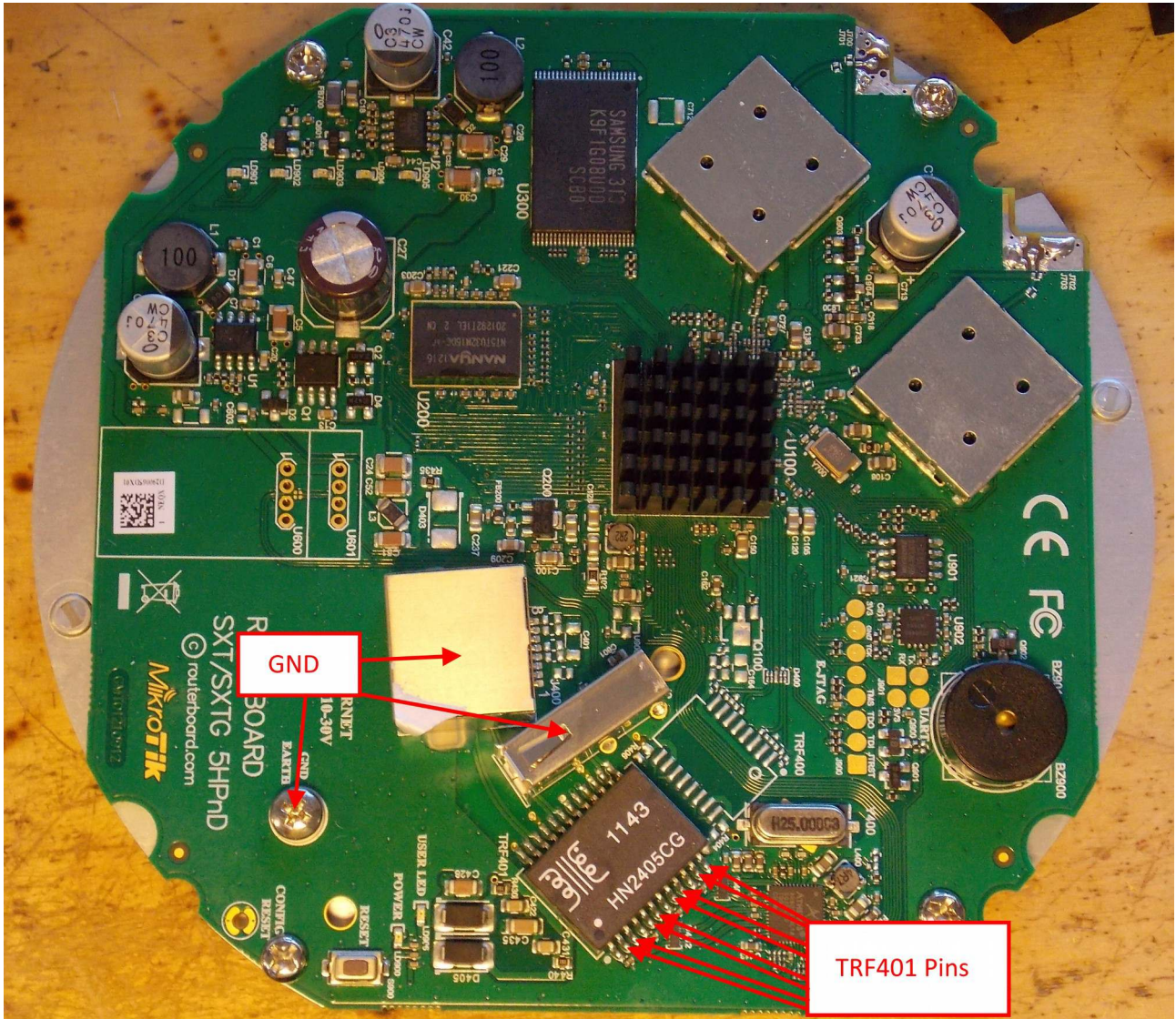

75R Termination resistors resistance.

Resistor resistance, marked with red arrow, should be 75 Ohm +/- 1%

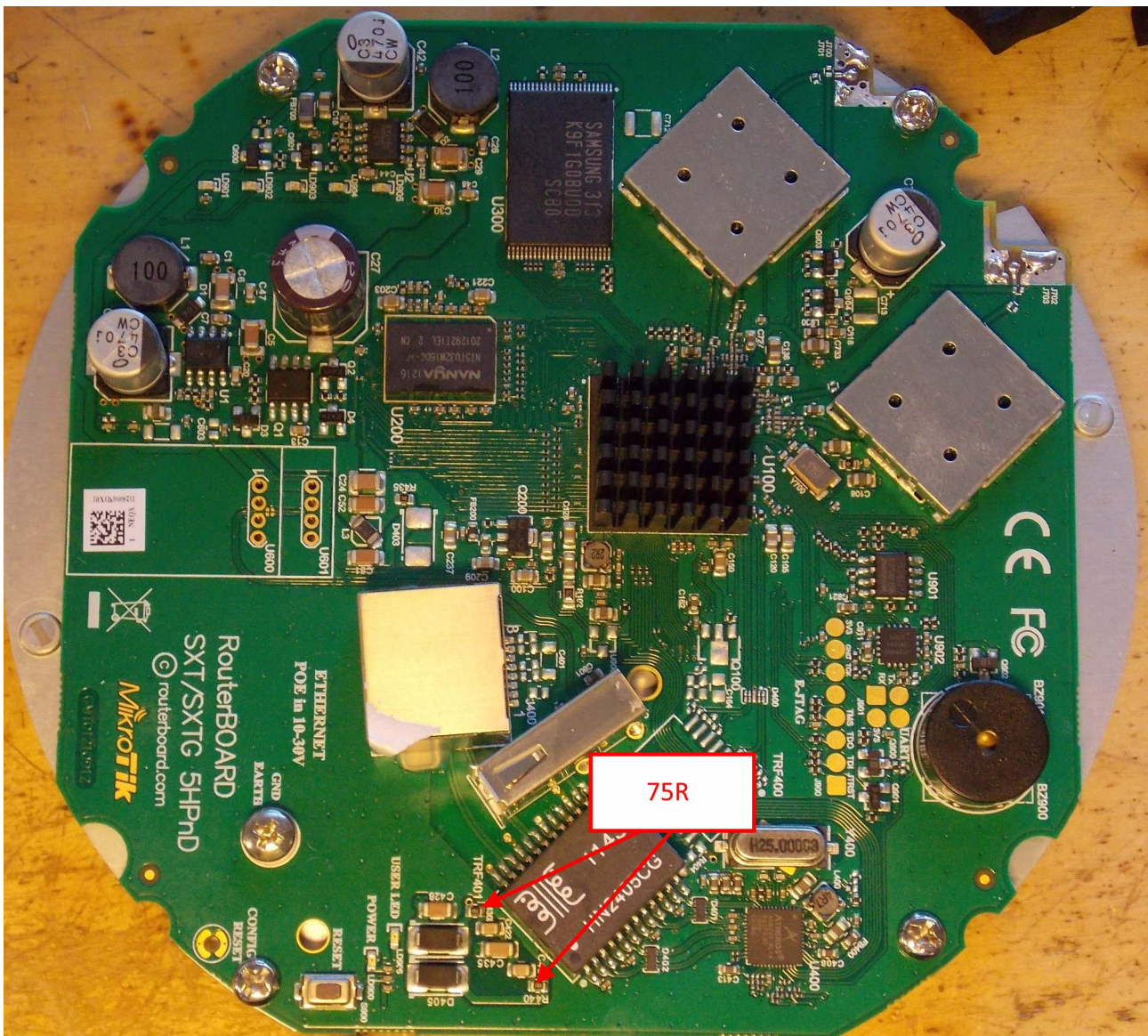

hAP lite series RouterBoards

hAP lite



1. Disassembling information

hAP lite horizontal case disassembling

1. step

Push “-” screwdrivers in case cavities.

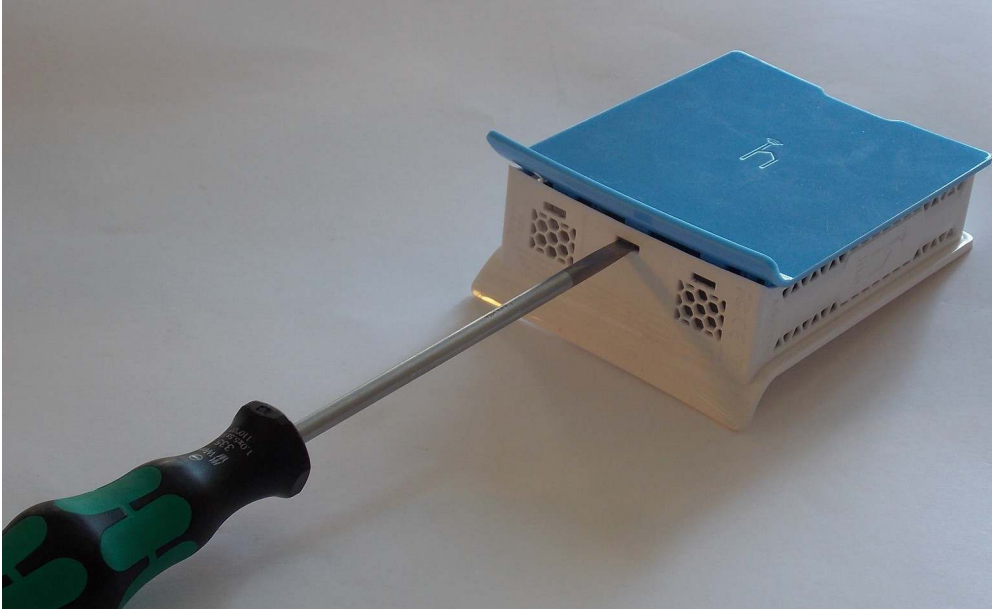

2. step

Rotate screwdriver and pull both case parts.

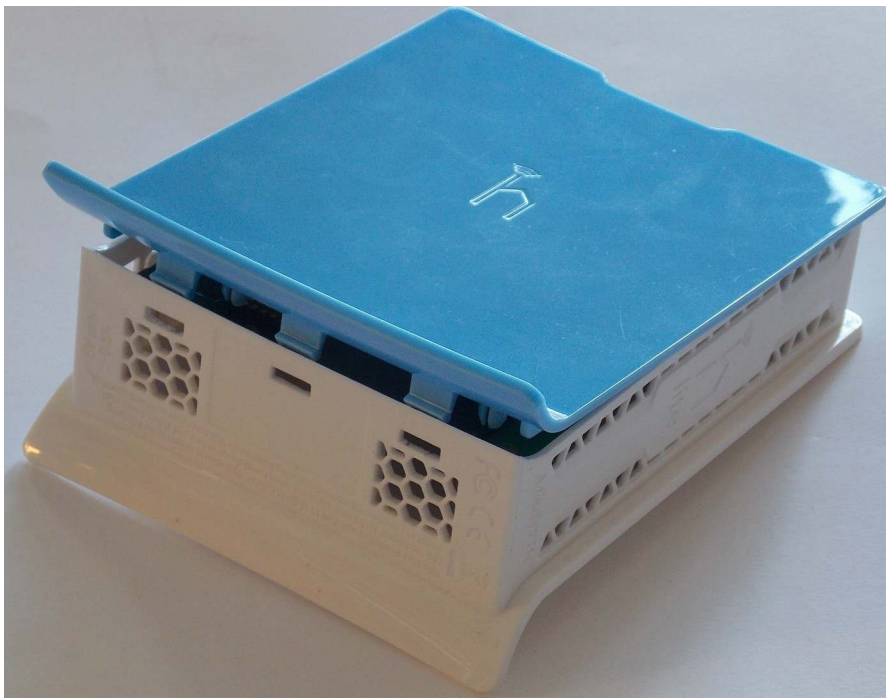

3. step

Open front case and take out the board.

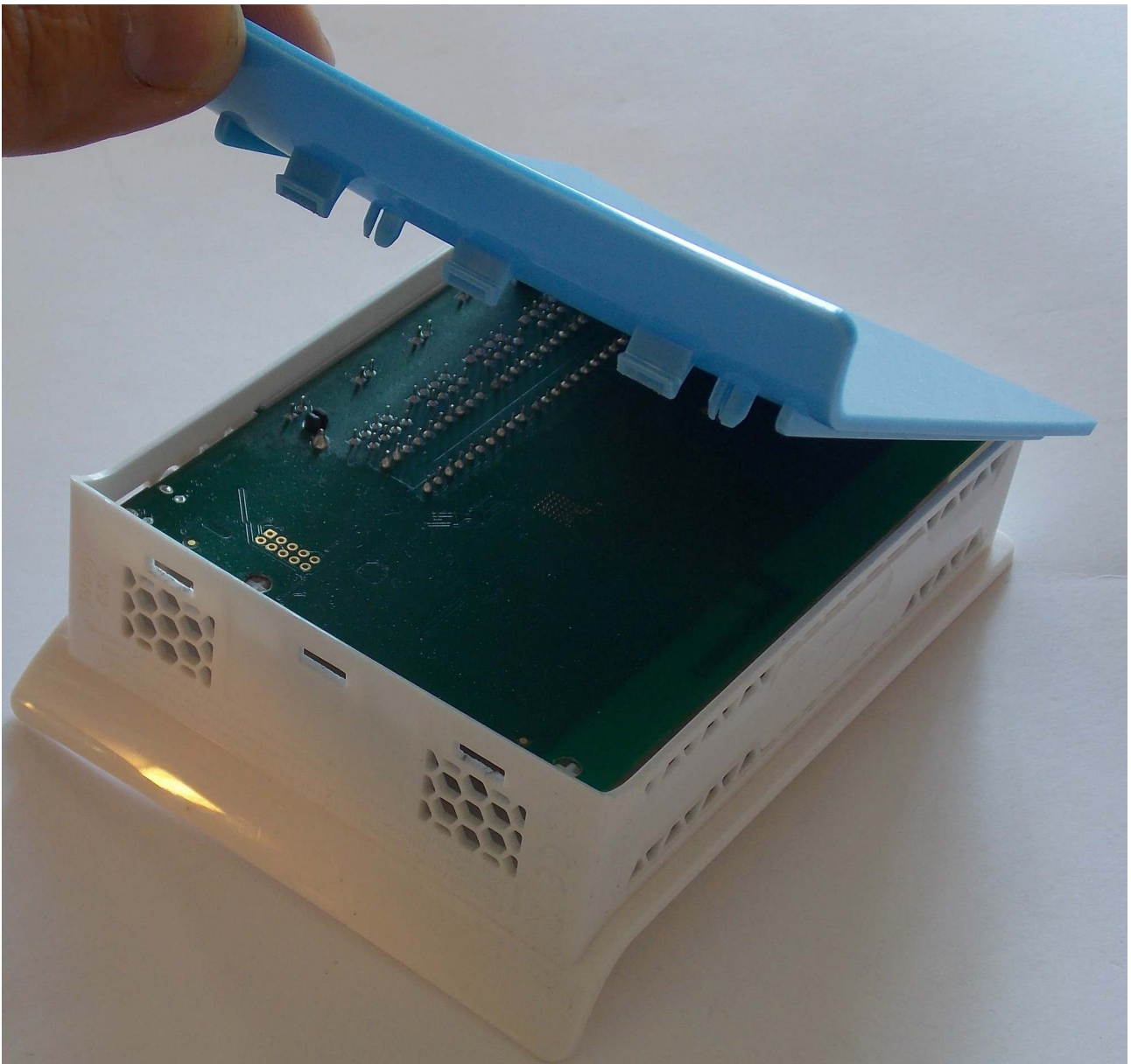

Horizontal case disassembling

Take off the cover with a screwdriver as shown in the picture1



Picture1

Take out the board with a screwdriver as shown in the picture2

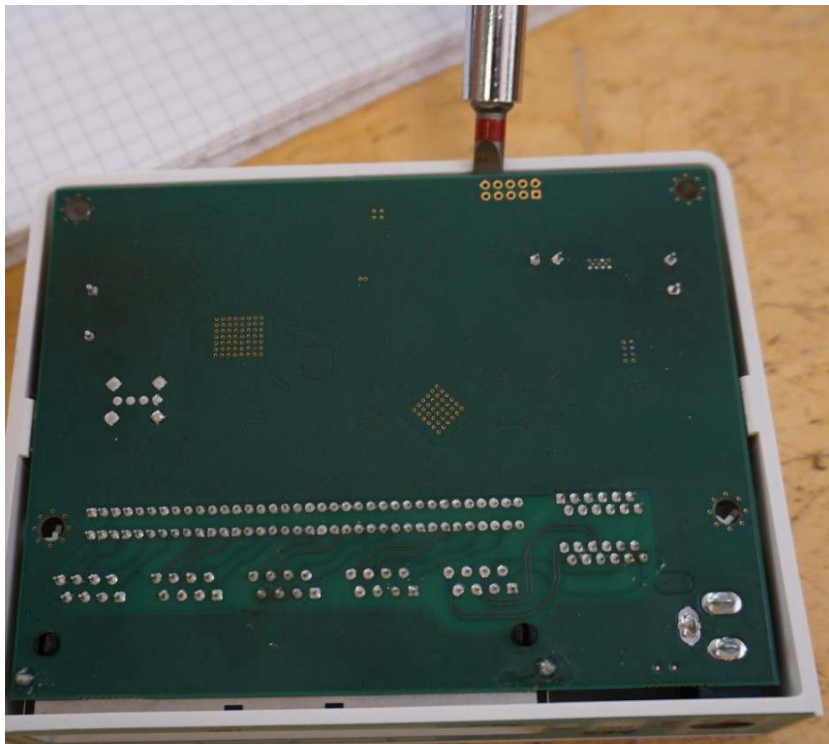

Picture1

Voltage drop between Ethernet signal lines and Ground.

Check voltage drop between TR1 Ethernet Transformers pins and Ground. Ether Pins are marked with red arrows.

It should be in the range from 0,32V to 0,48V

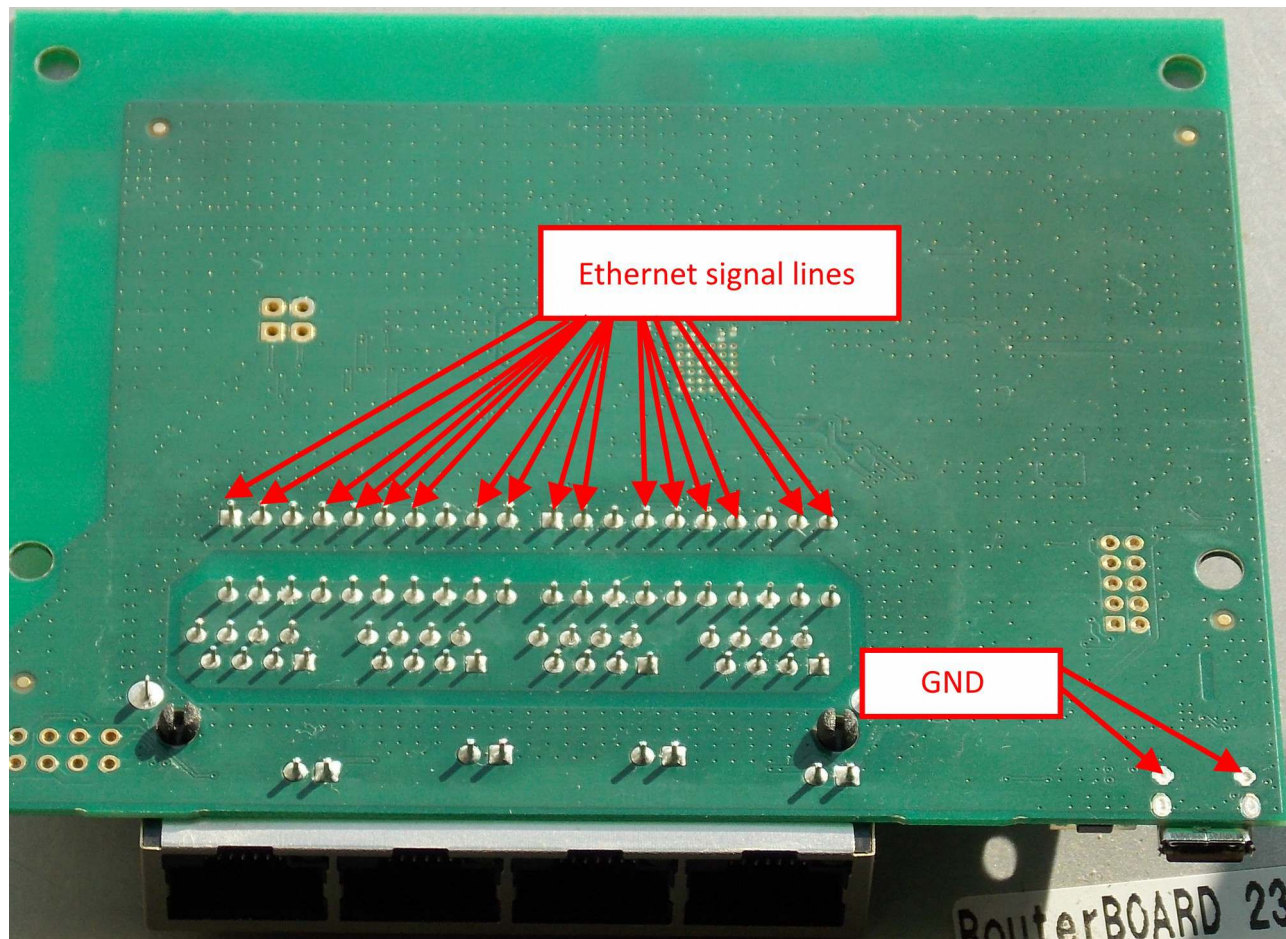

RB951G-2HnD series RouterBoards

RB951G-2HnD



Disassembling information

951G-2HnD disassembling

Take off the cover with a screwdriver as shown in the pictures



Take out the board with a screwdriver as shown in the picture



Schottky diode measuring with multimeter in diode mode

Diode bridge reference numbers are D4 and D6. Voltage drop value should be about 0,588V



Voltage drop between diode array pin#1 and Ground.

Check voltage drop between TR100 Ethernet Transformers on ports Ether1 – Ether5 pins and Ground. Ether Pins are marked with red arrows.

It should be in the range from 0,32V to 0,438V

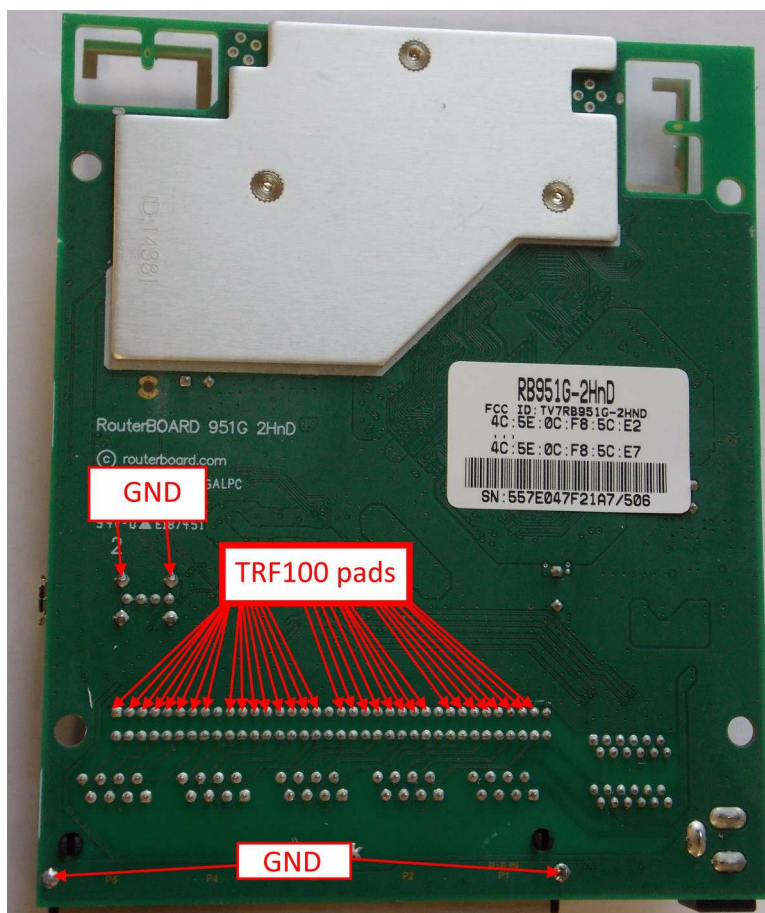

75R termination resistors resistance

Red circled resistors resistance should be 75R +/- 1%

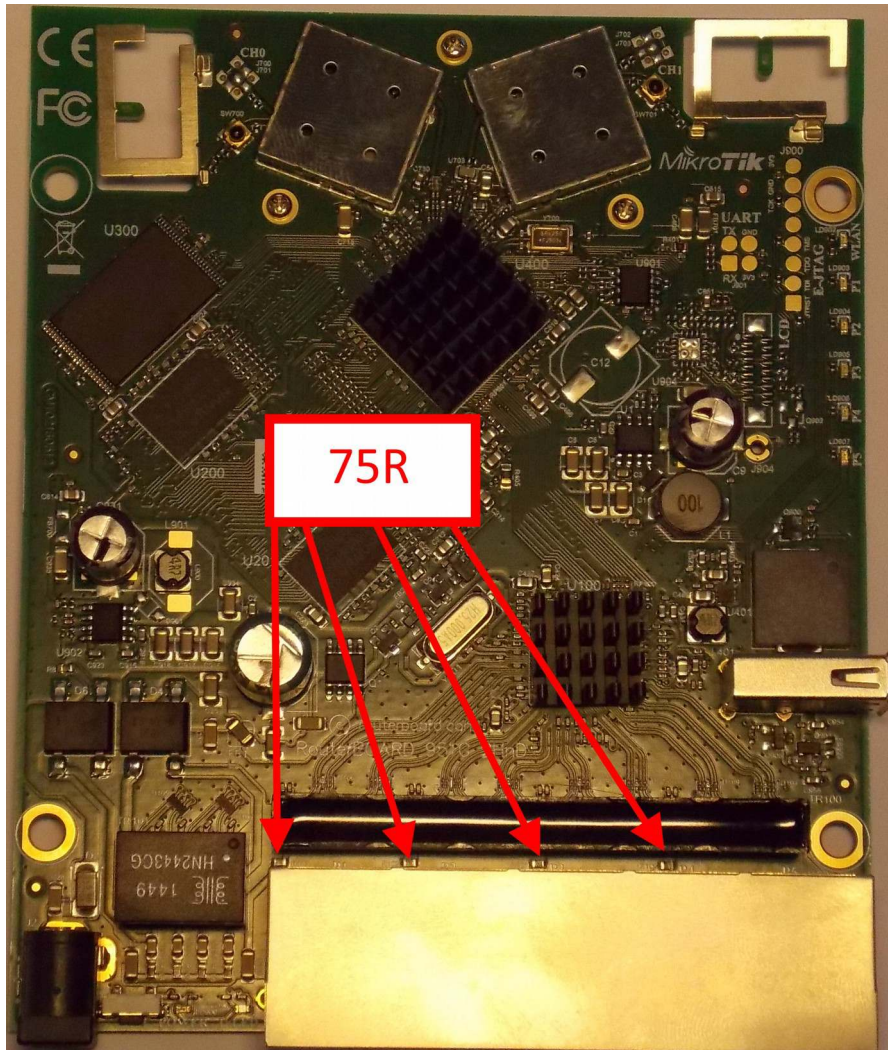

RB951Ui-2HnD series RouterBoards

RB951Ui-2HnD



Disassembling information

Take off the cover with a screwdriver as shown in the pictures



Take out the board with a screwdriver as shown in the picture



Schottky diode measuring with multimeter in diode mode

Diode bridge reference numbers are D2, D4 and D1000. Voltage drop value should be about 0,236V

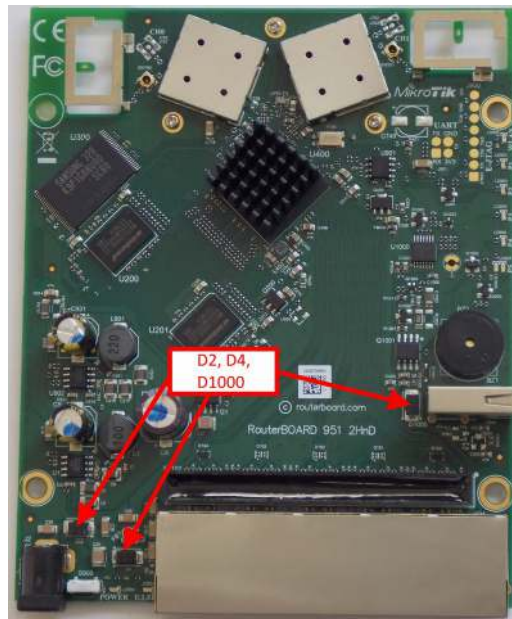

Voltage drop between diode array pin#1 and Ground.

Check voltage drop between TR100 Ethernet Transformers on ports Ether1 – Ether5 pins and Ground. Ether Pins are marked with red arrows.

It should be in the range from 0,32V to 0,438V

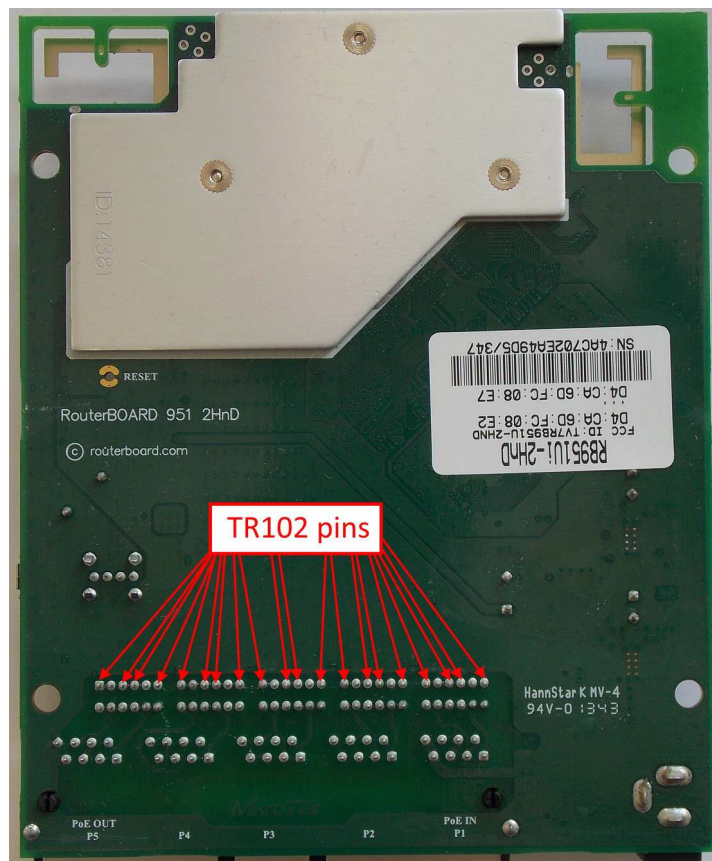

75R termination resistors resistance

Red circled resistors resistance should be 75R +/- 1%

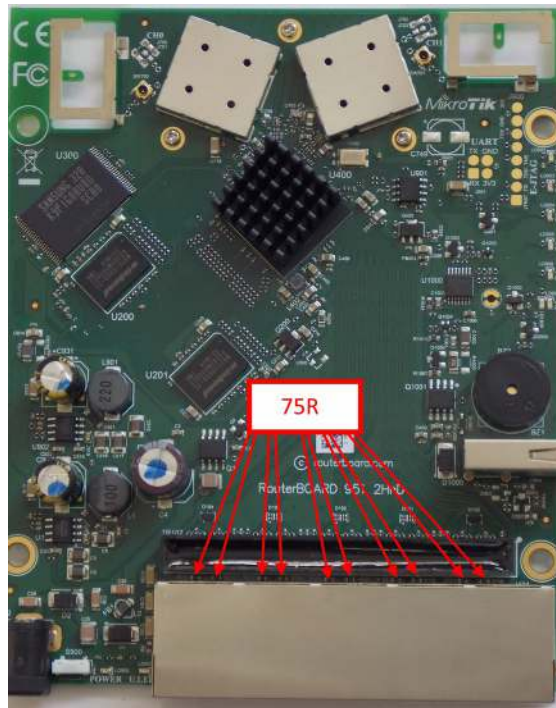

RB751U-2HnD series RouterBoards

RB751U-2HnD



Disassembling information

Take off the cover with a screwdriver as shown in the pictures



Take out the board with a screwdriver as shown in the picture



Schottky diode measuring with multimeter in diode mode

Diode bridge reference numbers are D2 and D4. Voltage drop value should be about 0,222V

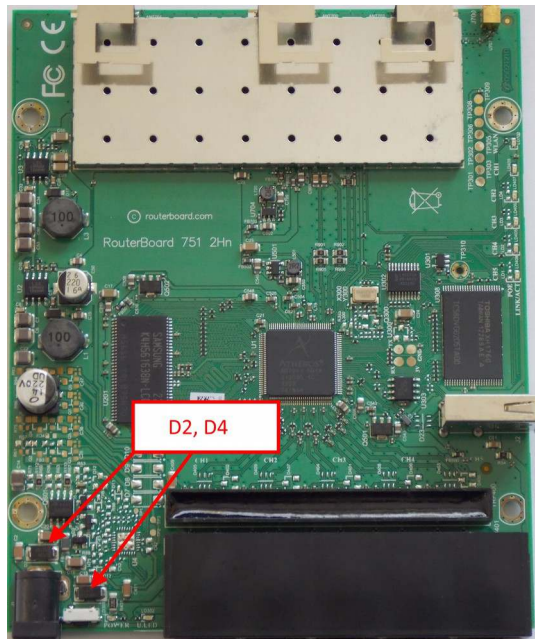

Voltage drop between diode array pin#1 and Ground.

Check voltage drop between TR100 Ethernet Transformers on ports Ether1 – Ether5 pins and Ground. Ether Pins are marked with red arrows.

It should be in the range from 0,32V to 0,438V

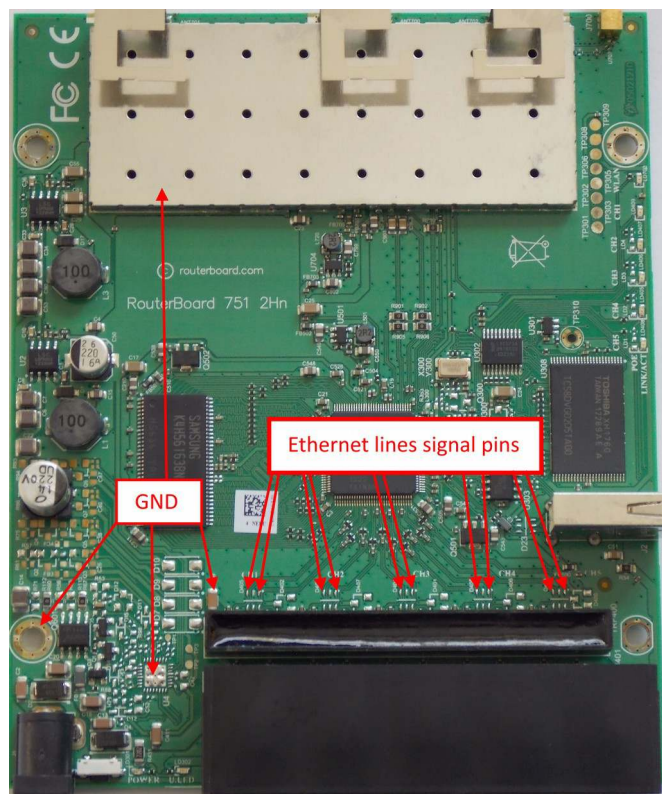

75R termination resistors resistance

Red circled resistors resistance should be 75R +/- 1%

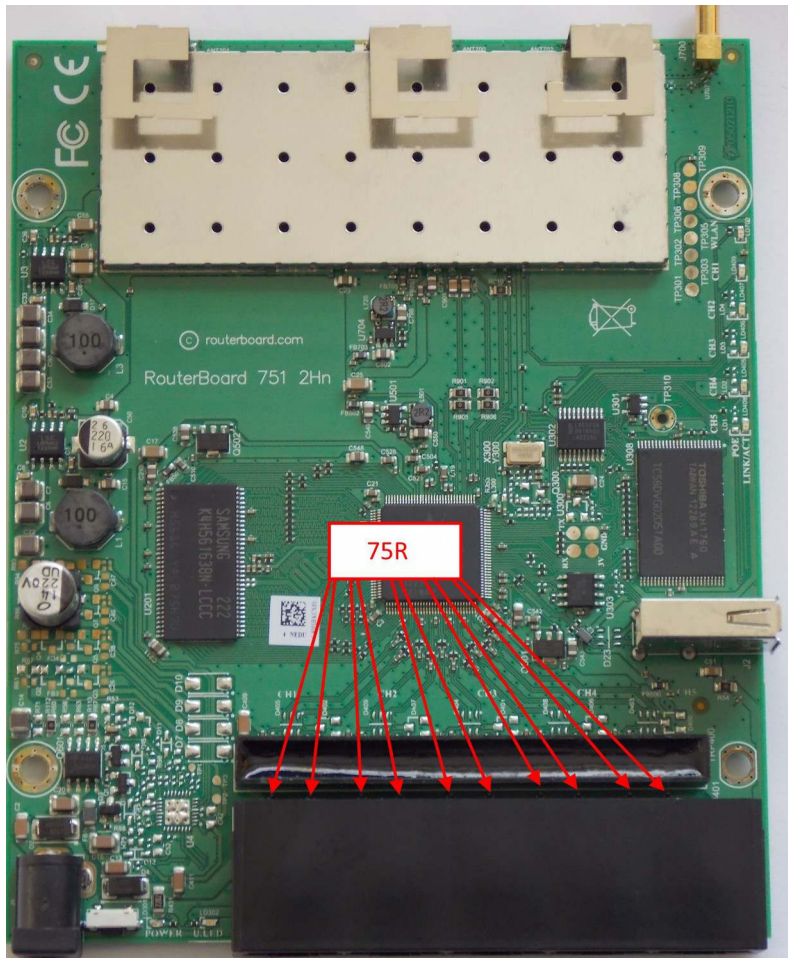

RB951-2n series RouterBoards

RB951-2n



Disassembling information

Take off the cover with a screwdriver as shown in the picture1

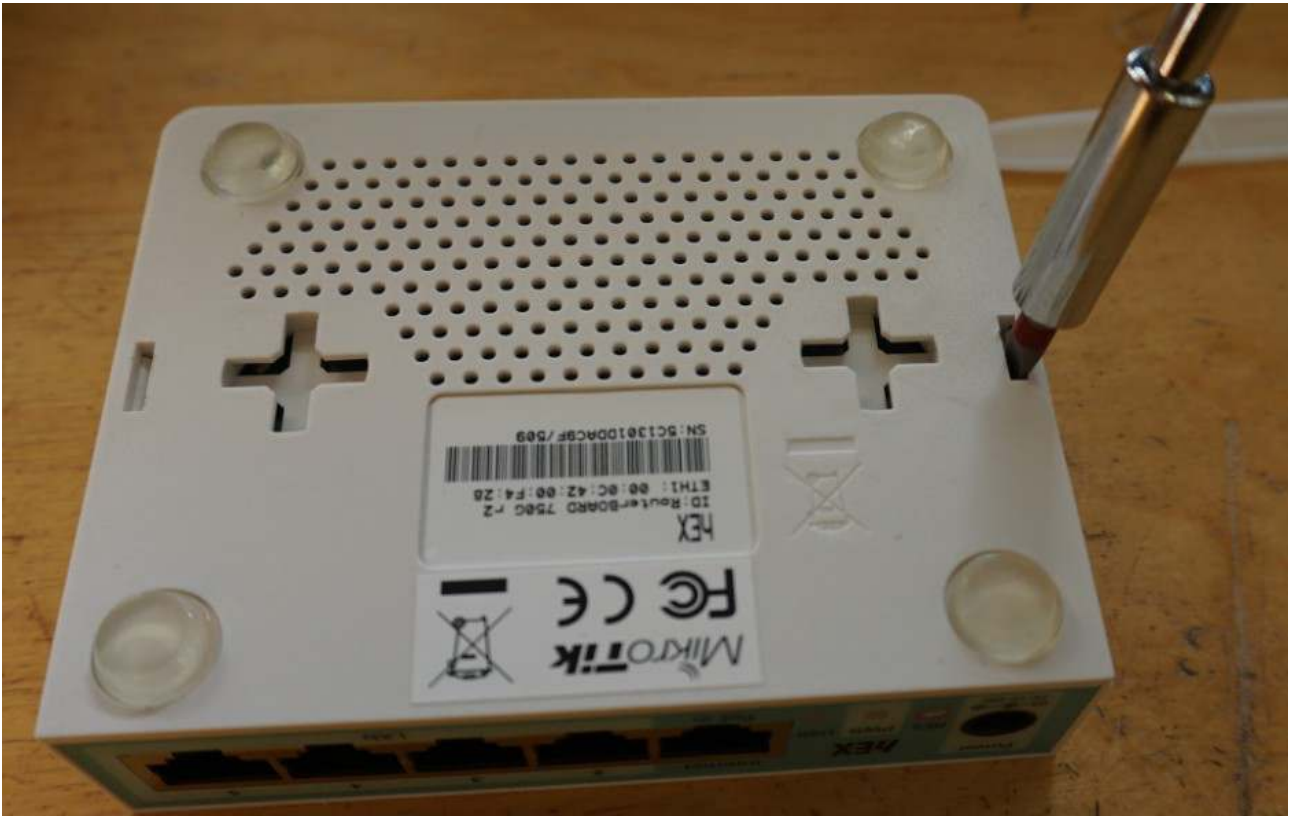

Picture1

Take out the board with a screwdriver as shown in the picture2

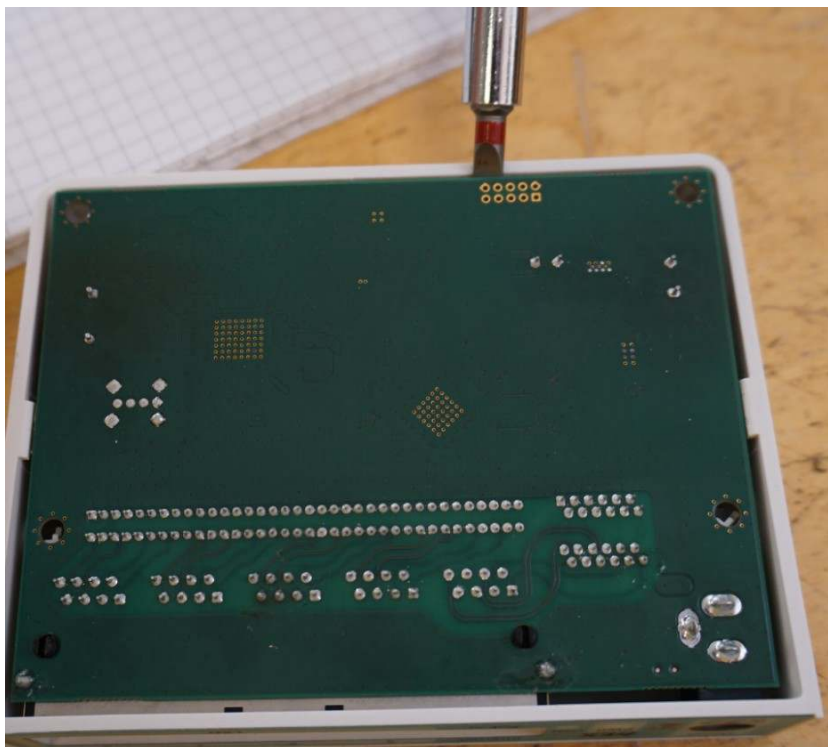

Picture1

Schottky diode measuring with multimeter in diode mode

Schottky diode reference numbers are D400, D402. Voltage drop value should be about 0,215V

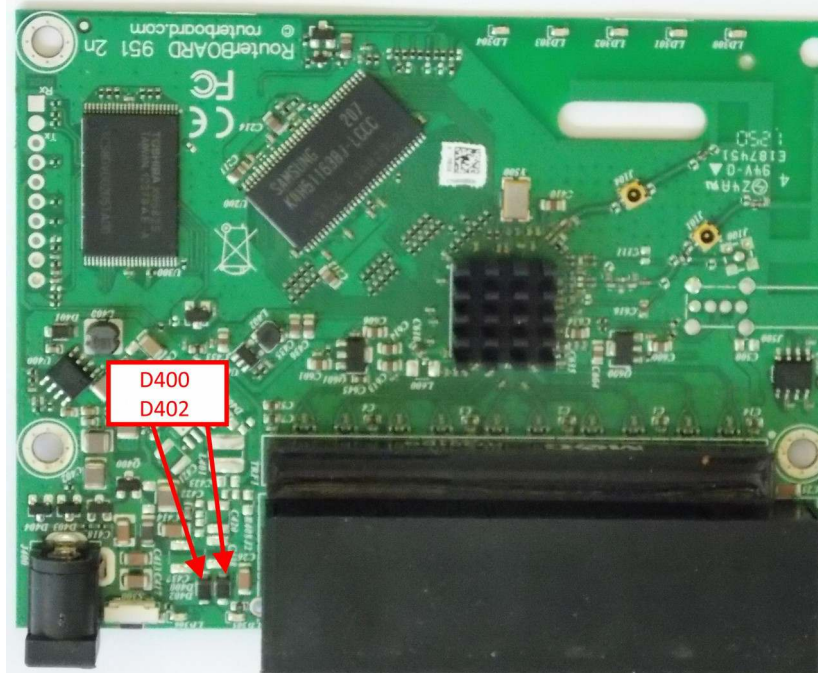

Voltage drop between diode array pin#1 and Ground.

Check voltage drop between TR1 Ethernet Transformers on ports Ether1 – Ether5 pins and Ground. Ether Pins are circled red.

It should be in the range from 0,32V to 0,438V

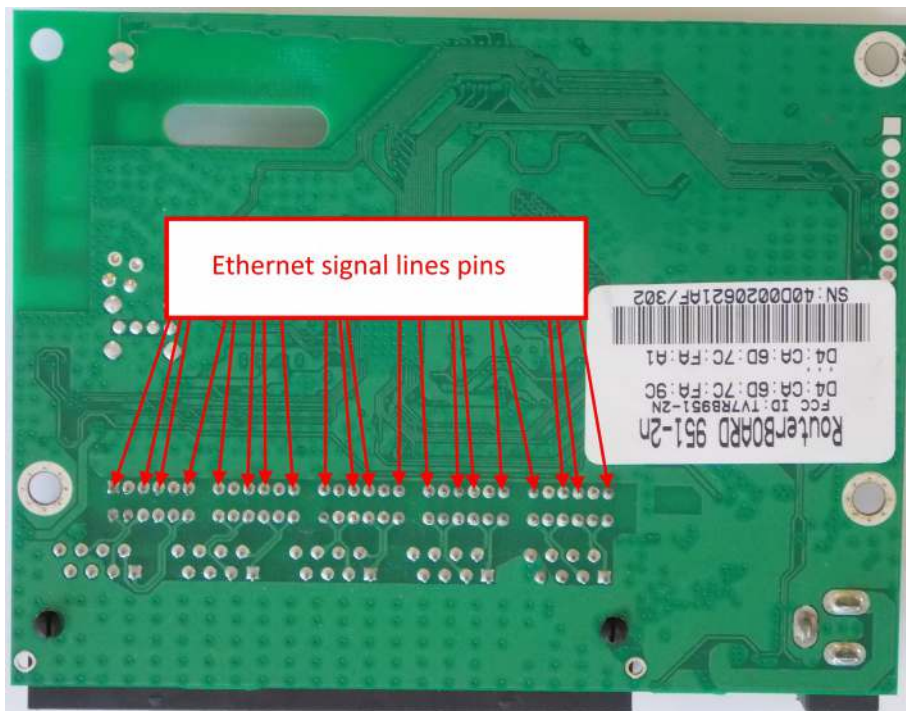

75R termination resistors resistance

Red circled resistors resistance should be 75Ohm +/- 1%

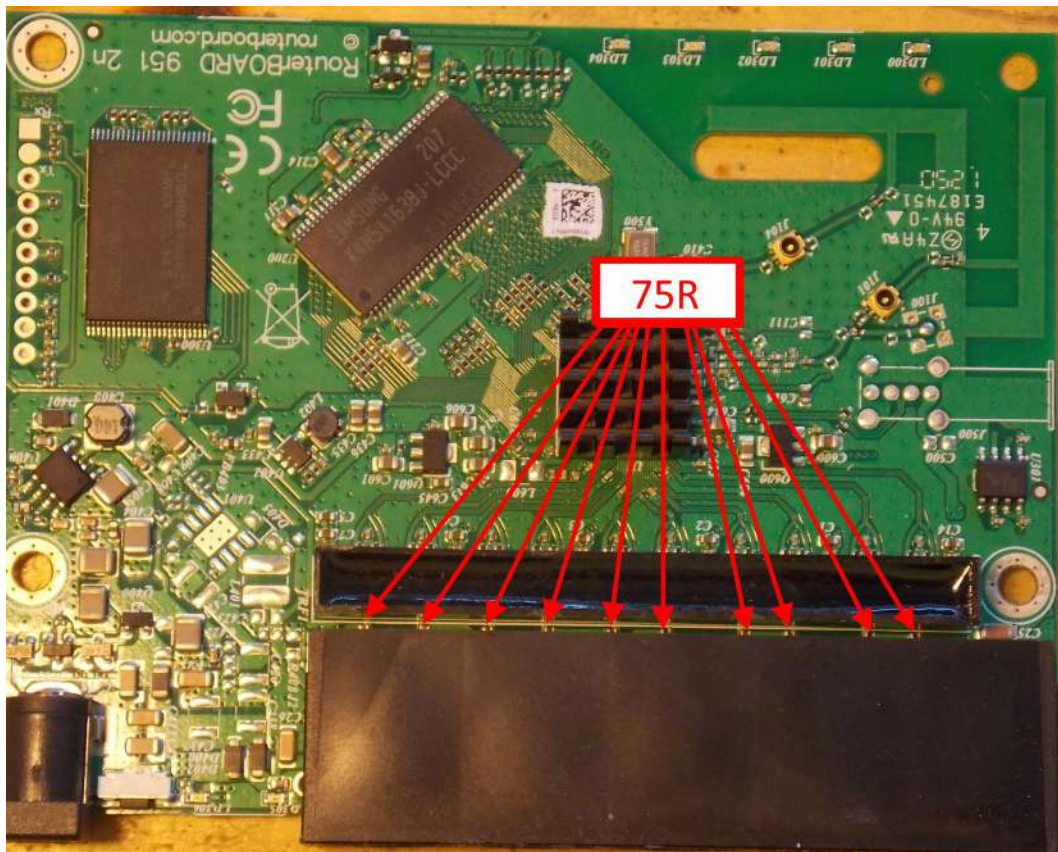

CRS112-8G-4S series RouterBoards

CRS112-8G-4S-IN

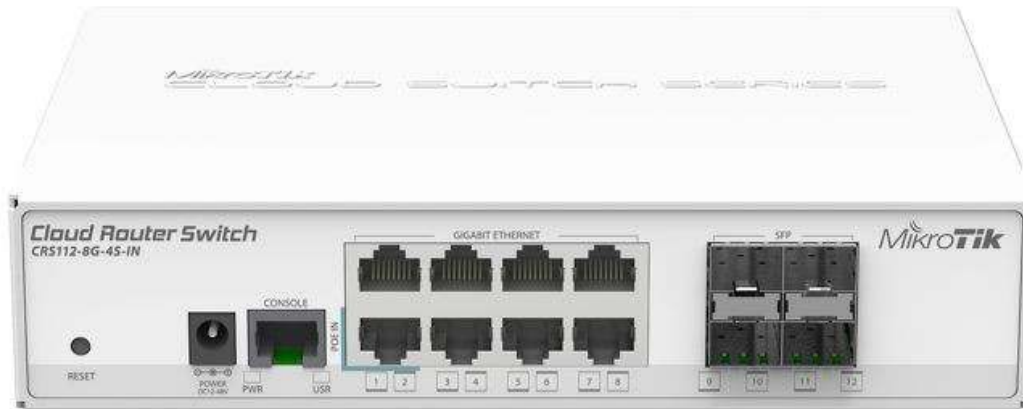

Disassembling information

1. Step: use PH2 screw driver to loose backside screws, take off cover.

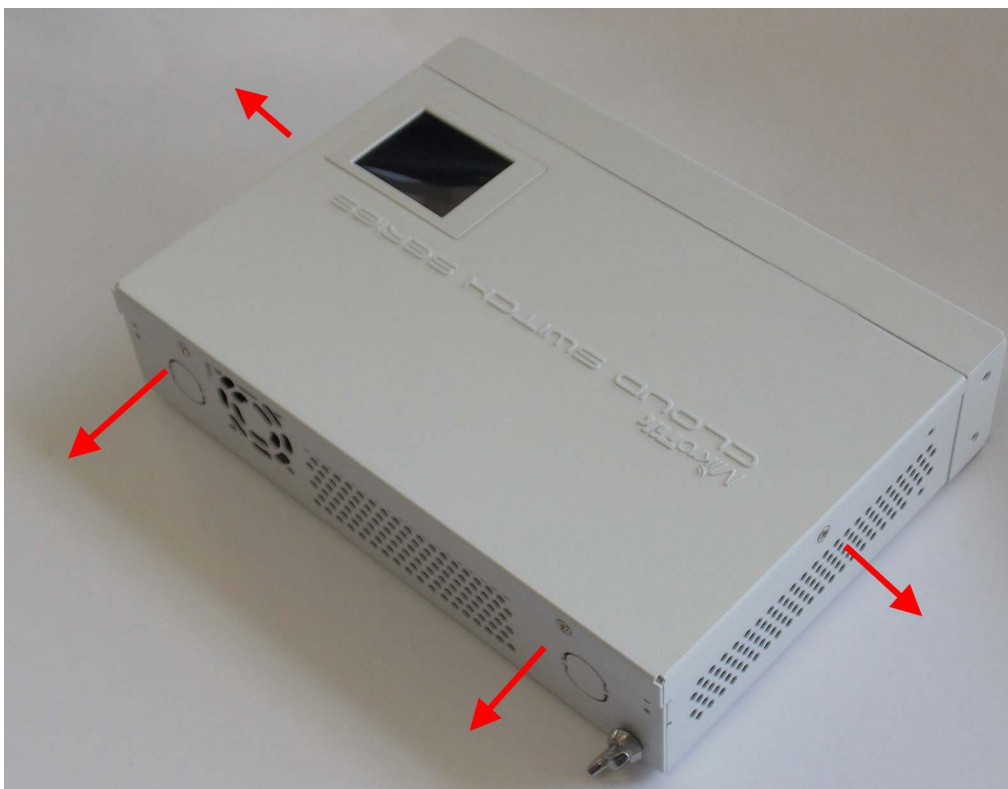

2. step: take off cover carefully, pay a tension to LCD connector. Push up both side of LCD connector from slot with “-” screwdriver as shown in next pictures

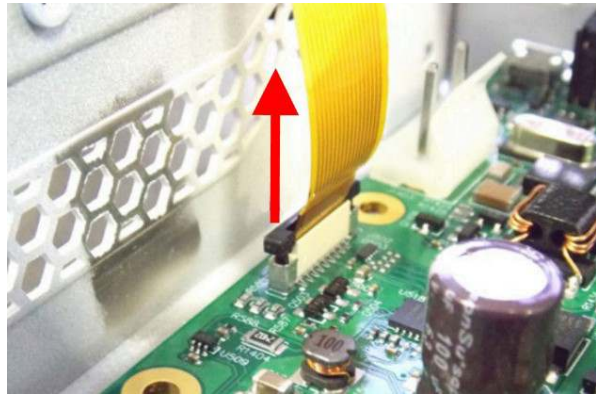

3. Step: use “+” screw driver to loose 7 pcs PCB screws, than take off PCB from case.

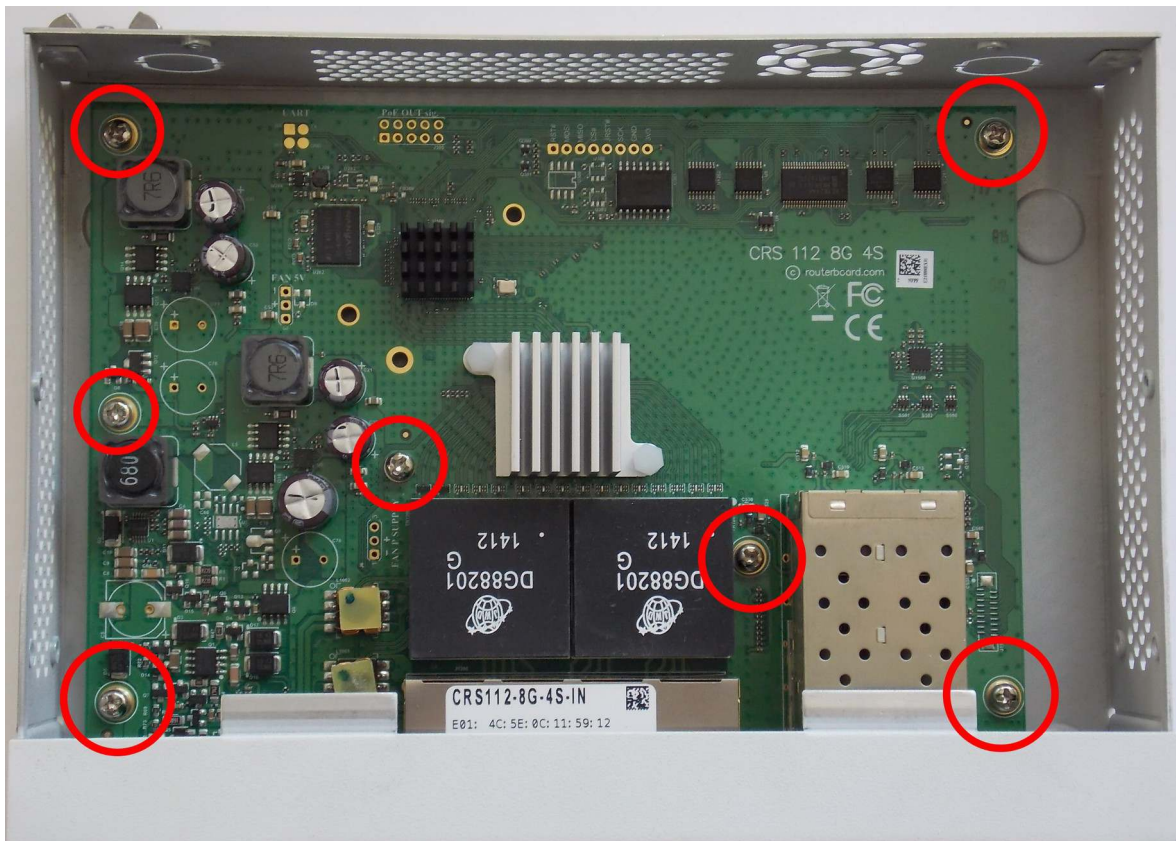

Schottky diode measuring with multimeter in diode mode

Schottky diode reference numbers are D3, D5, D11, D16, D17. Voltage drop value should be about 0,215V

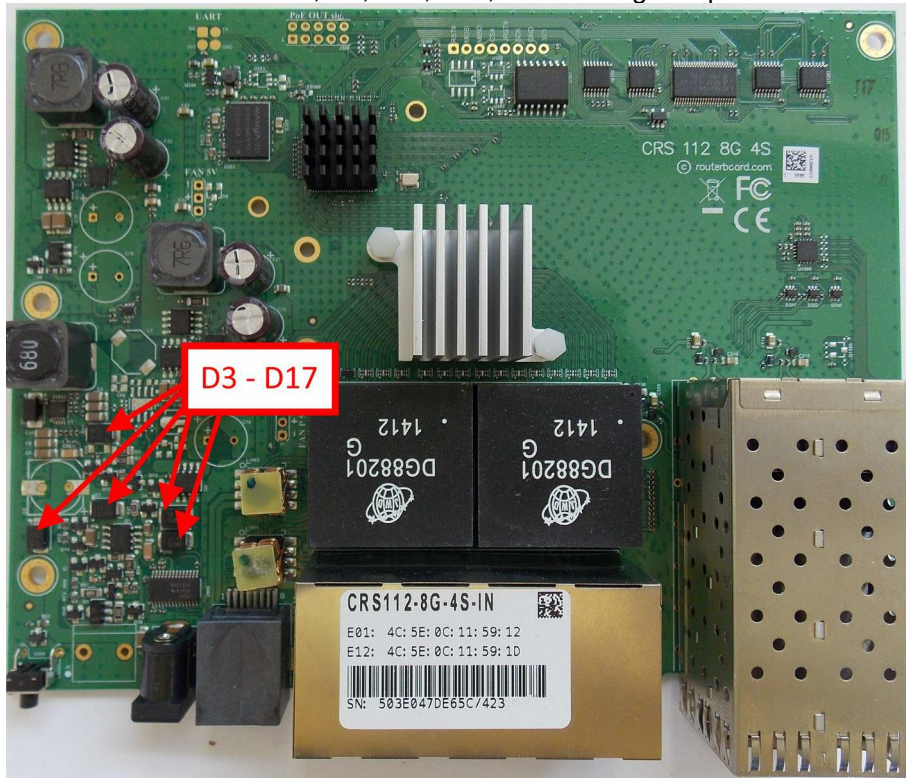

Voltage drop between diode array pin#1 and Ground.

Check voltage drop between TR1200 and TR1201 Ethernet Transformers on ports Ether1 – Ether8 pins and Ground. Ether Pins are circled red.

It should be in the range from 0,32V to 0,438V

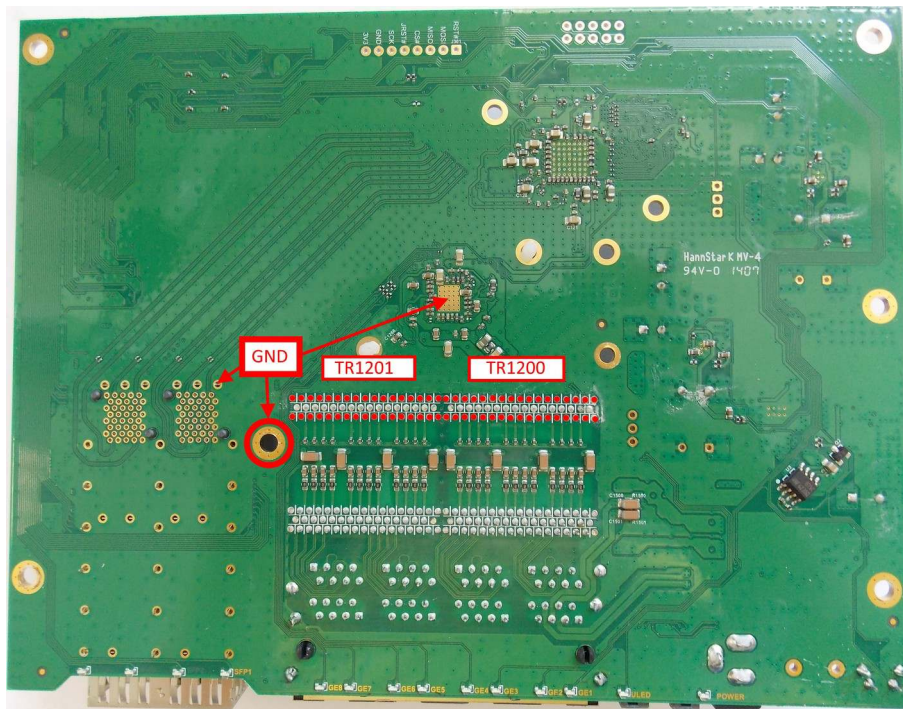

75R termination resistors resistance

Resistors marked with red arrows should be 75Ohm +/- 1%

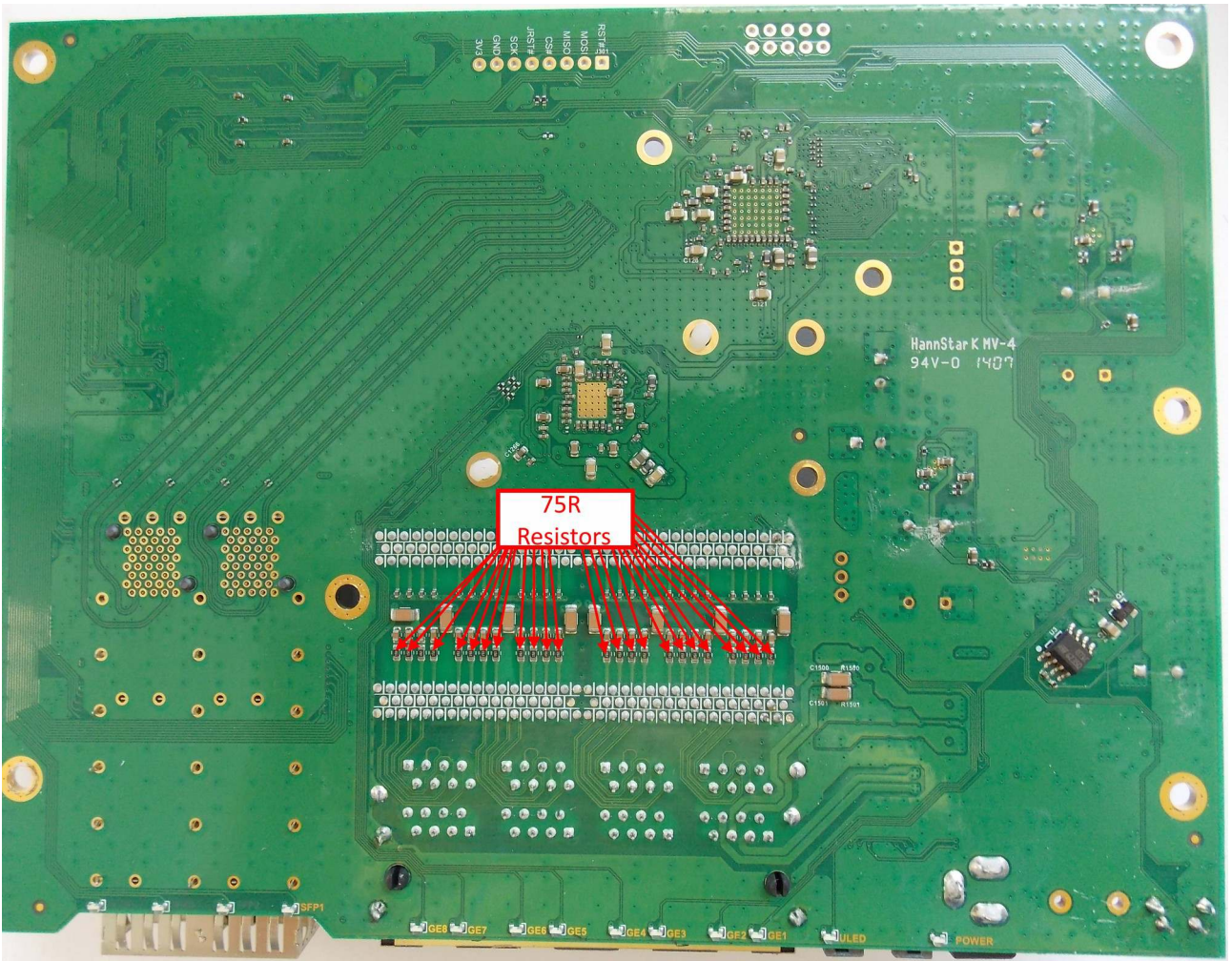

CRS210-8G-2S+ series RouterBoards

CRS210-8G-2S+IN



Disassembling information

1. Step: use PH2 screw driver to loose backside screws, take off cover.

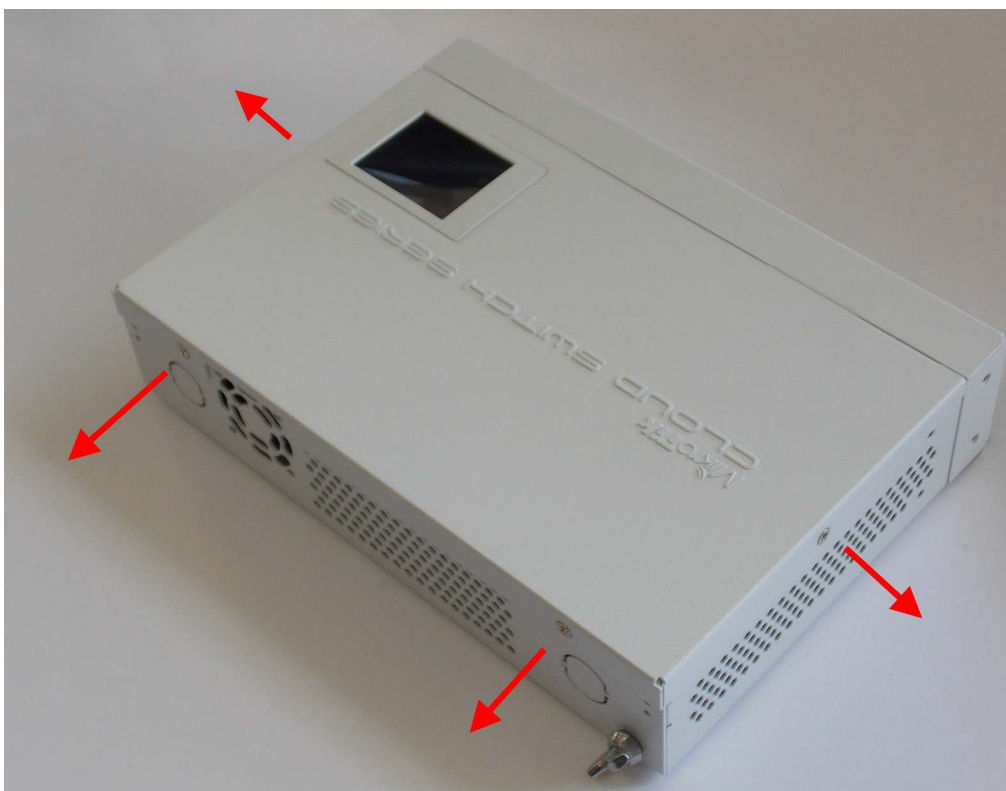

2. step: take off cover carefully, pay a tension to LCD connector. Push up both side of LCD connector from slot with “-” screwdriver as shown in next pictures

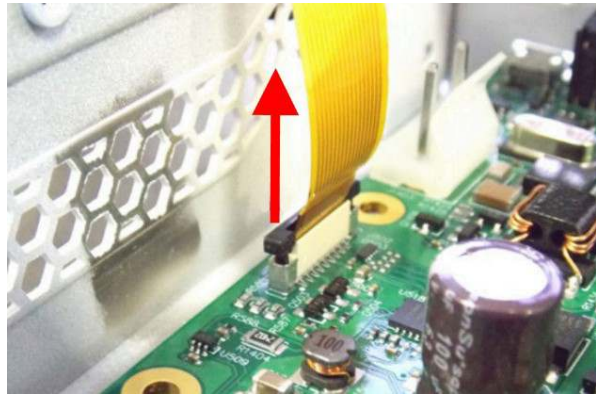

3. Step: use “+” screw driver to loose 7 pcs PCB screws, than take off PCB from case.

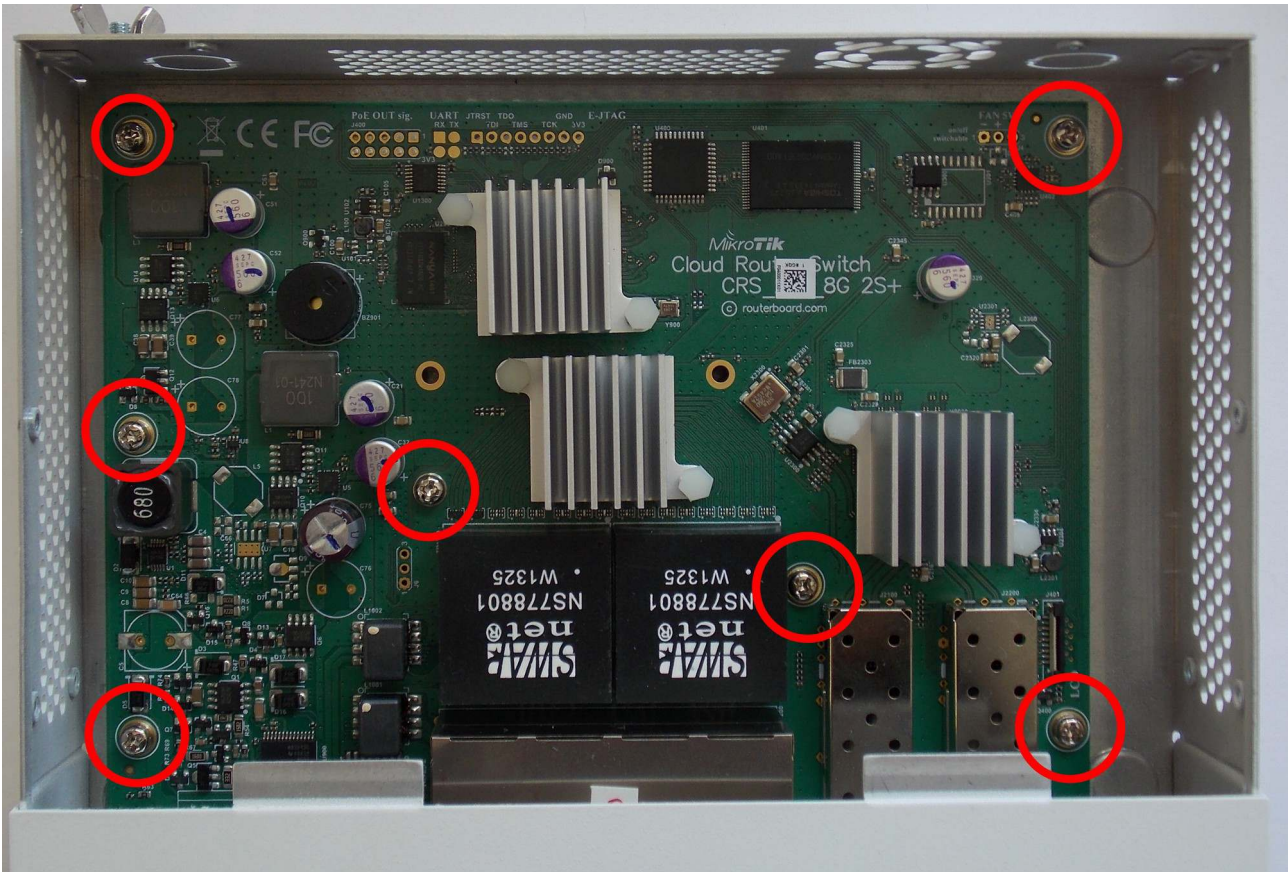

Schottky diode measuring with multimeter in diode mode

Schottky diode reference numbers are D3, D5, D11, D16, D17. Voltage drop value should be about 0,215V

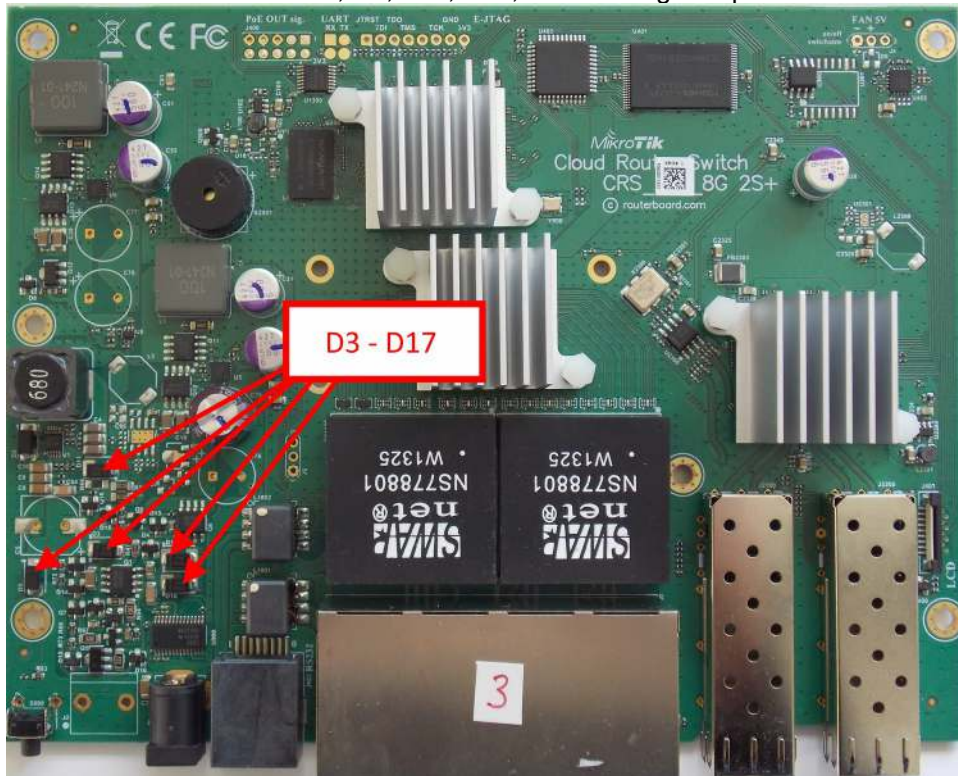

Voltage drop between diode array pin#1 and Ground.

Check voltage drop between TR1200 and TR1201 Ethernet Transformers on ports Ether1 – Ether8 pins and Ground. Ether Pins are circled red. It should be in the range from 0,32V to 0,438V

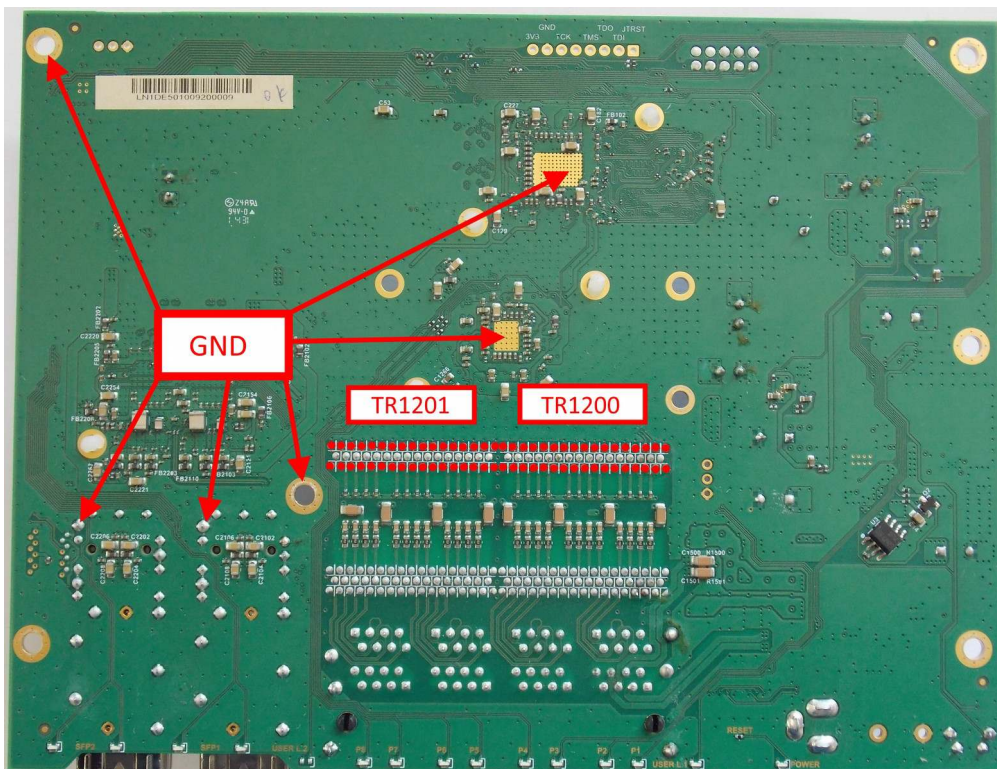

75R termination resistors resistance

Resistors marked with red arrows should be 75Ohm +/- 1%

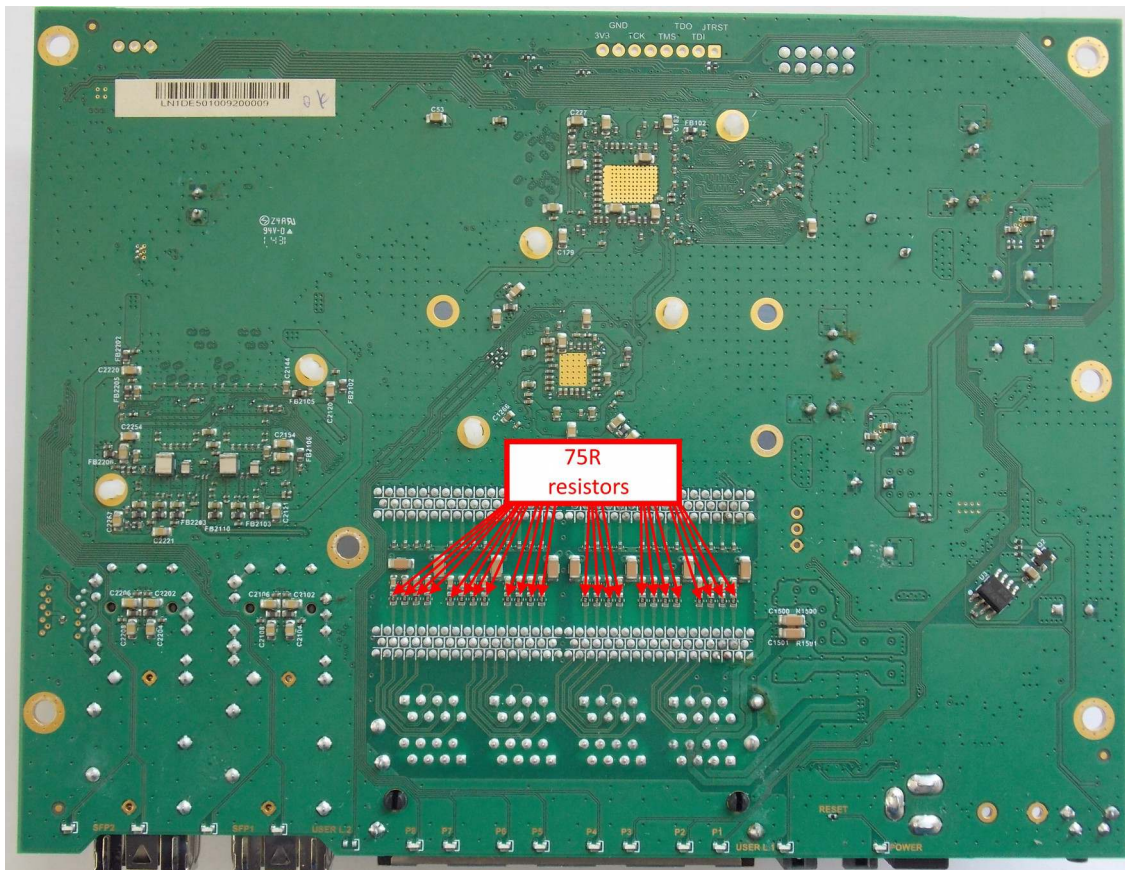

CRS212-1G-10S-1S+ series RouterBoards

CRS212-1G-10S-1S+IN

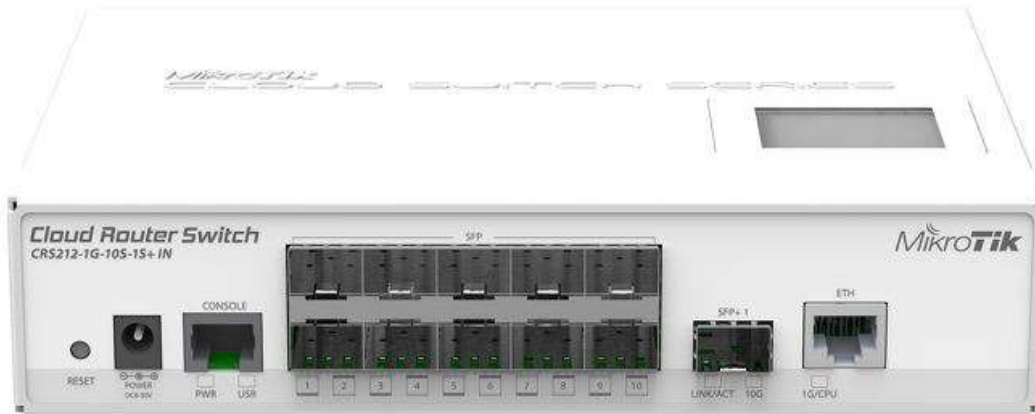

Disassembling information

1. Step: use PH2 screw driver to loose backside screws, take off cover.

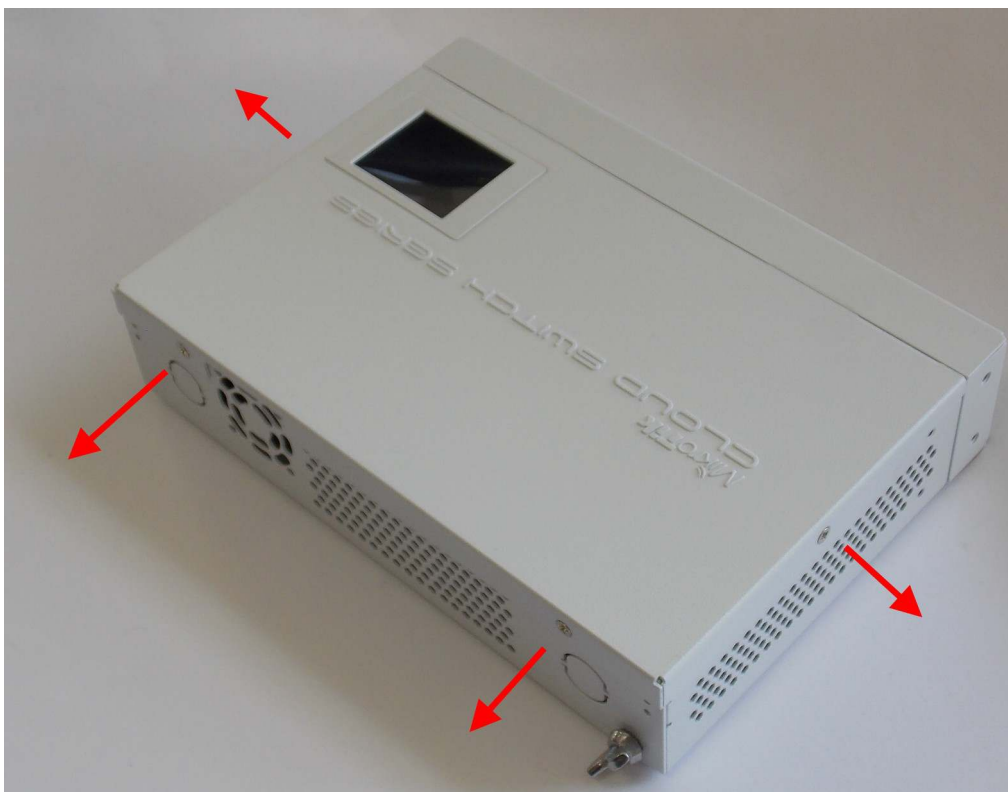

2. step: take off cover carefully, pay a tension to LCD connector. Push up both side of LCD connector from slot with “-” screwdriver as shown in next pictures

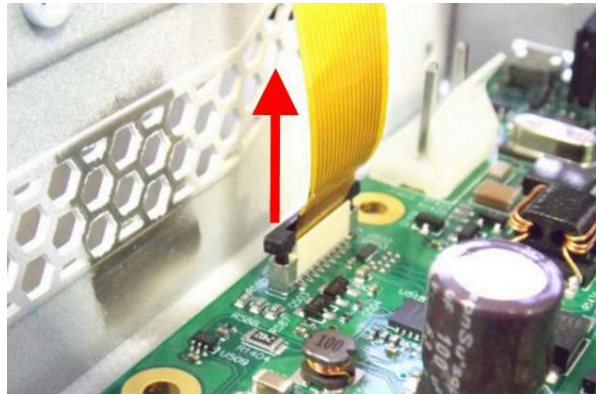

3. Step: use “+” screw driver to loose 7 pcs PCB screws, than take off PCB from case.

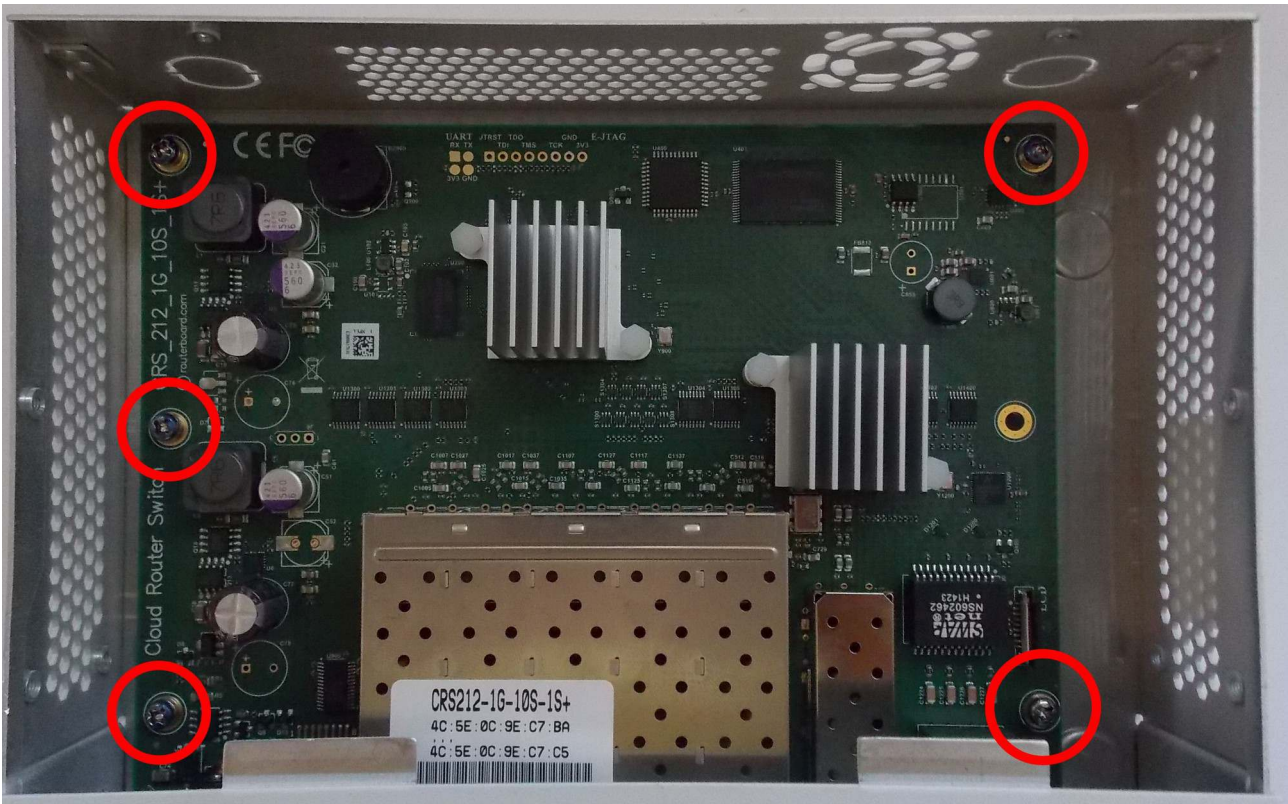

Schottky diode measuring with multimeter in diode mode

Schottky diode reference numbers are D5. Voltage drop value should be about 0,215V



Voltage drop between diode array pin#1 and Ground.

Check voltage drop between TRF1200 Ethernet Transformers on ports Ether1 pins and Ground. Ether Pins are marked with red arrows. It should be in the range from 0,32V to 0,438V

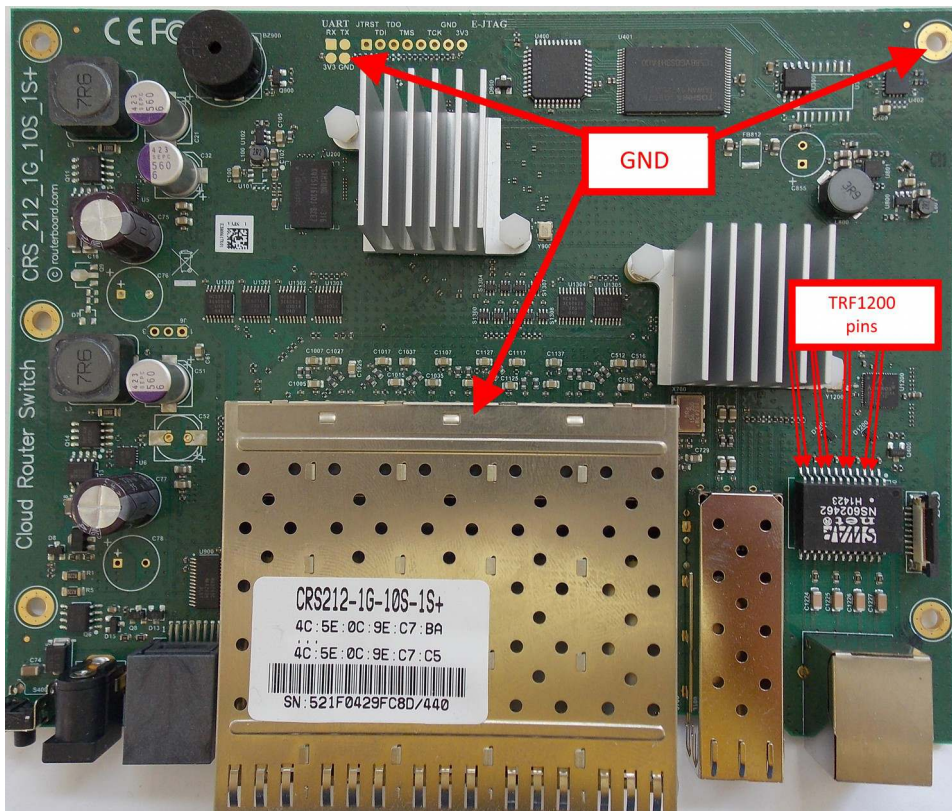

75R termination resistors resistance

Resistors marked with red arrows should be 75Ohm +/- 1%

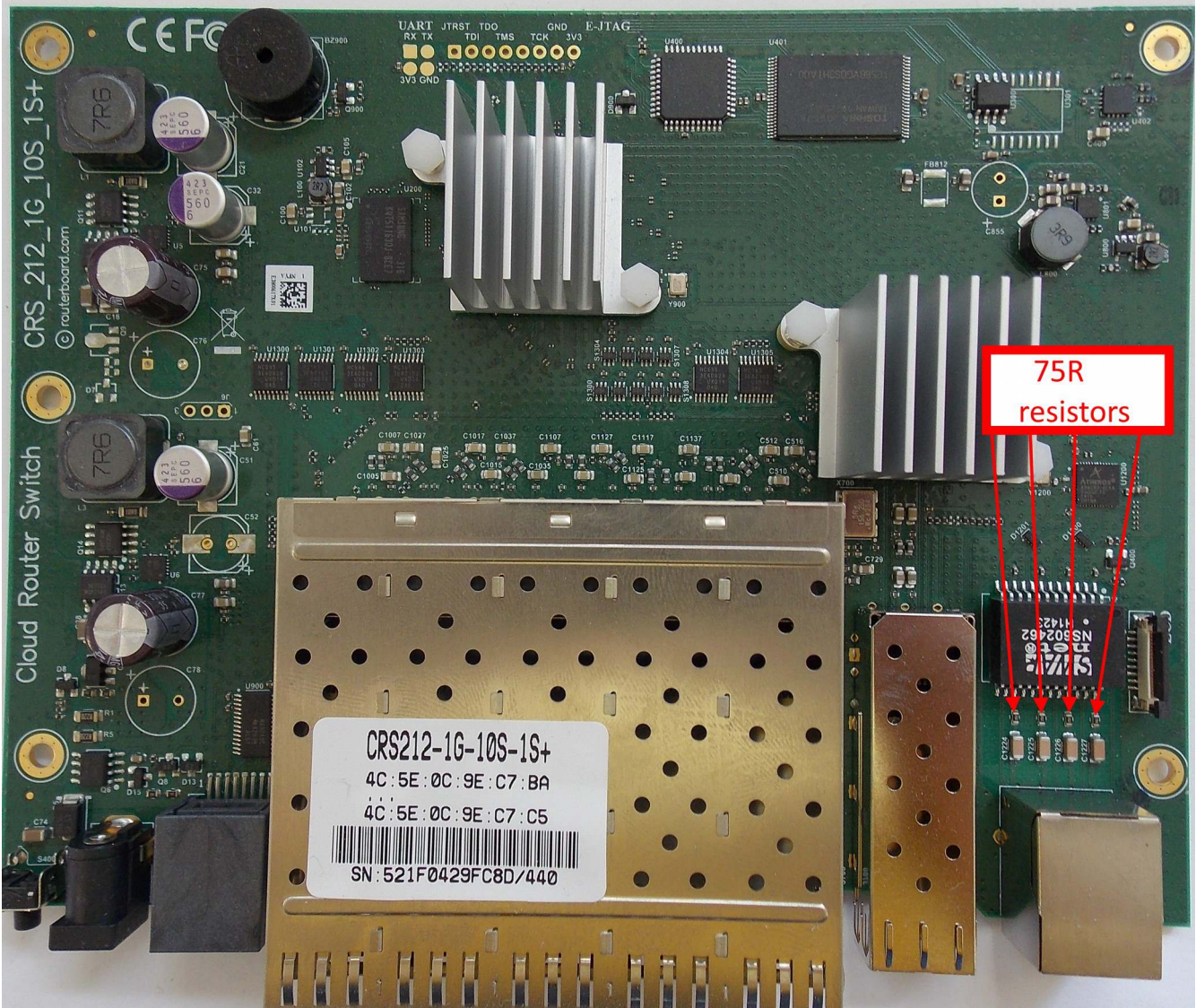

CRS109-8G-4S series RouterBoards

CRS109-8G-1S-2HnD-IN



Disassembling information

1. Step: use PH2 screw driver to loose backside screws, take off cover.

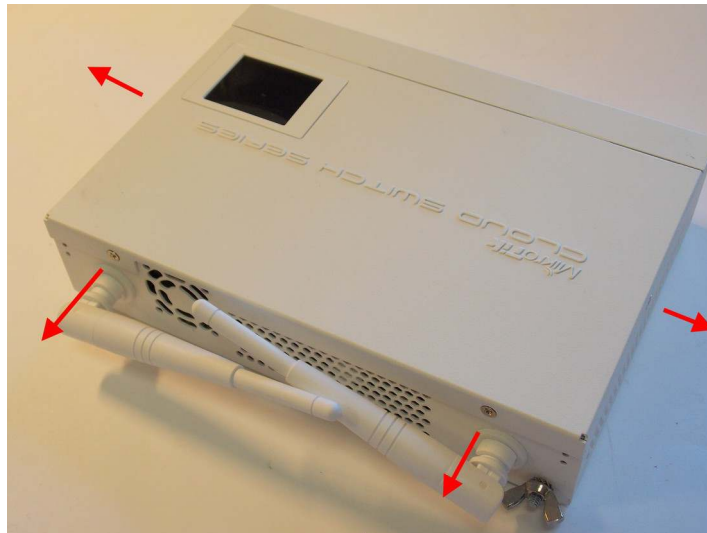

2. step: take off cover carefully, pay a tension to LCD connector. Push up both side of LCD connector from slot with “-” screwdriver as shown in next pictures

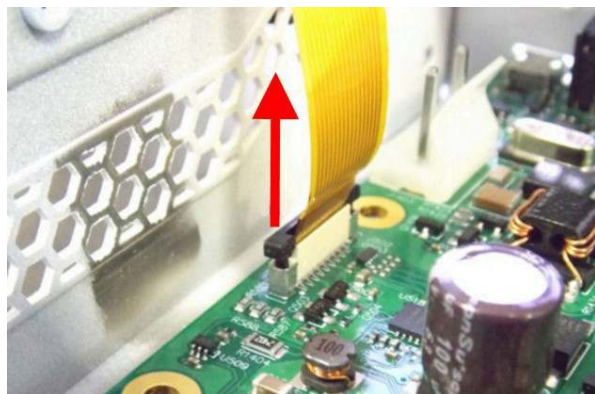
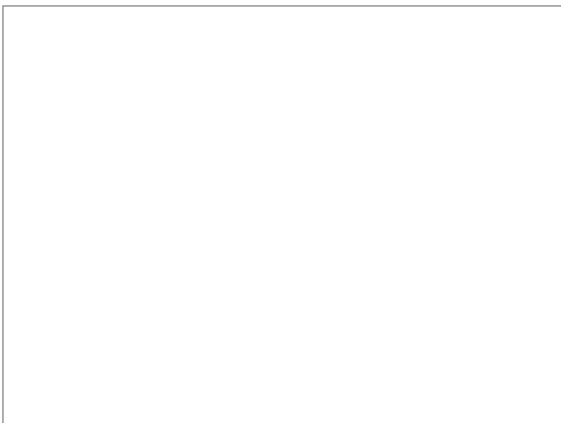

3. Step: use “+” screw driver to loose 7 pcs PCB screws, than take off PCB from case.

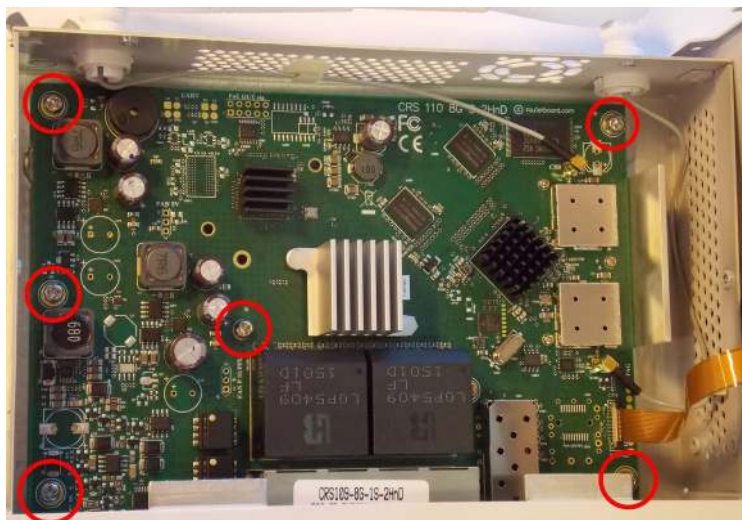

Schottky diode measuring with multimeter in diode mode

Schottky diode reference numbers are D3, D5, D11, D16, D17. Voltage drop value should be about 0,215V

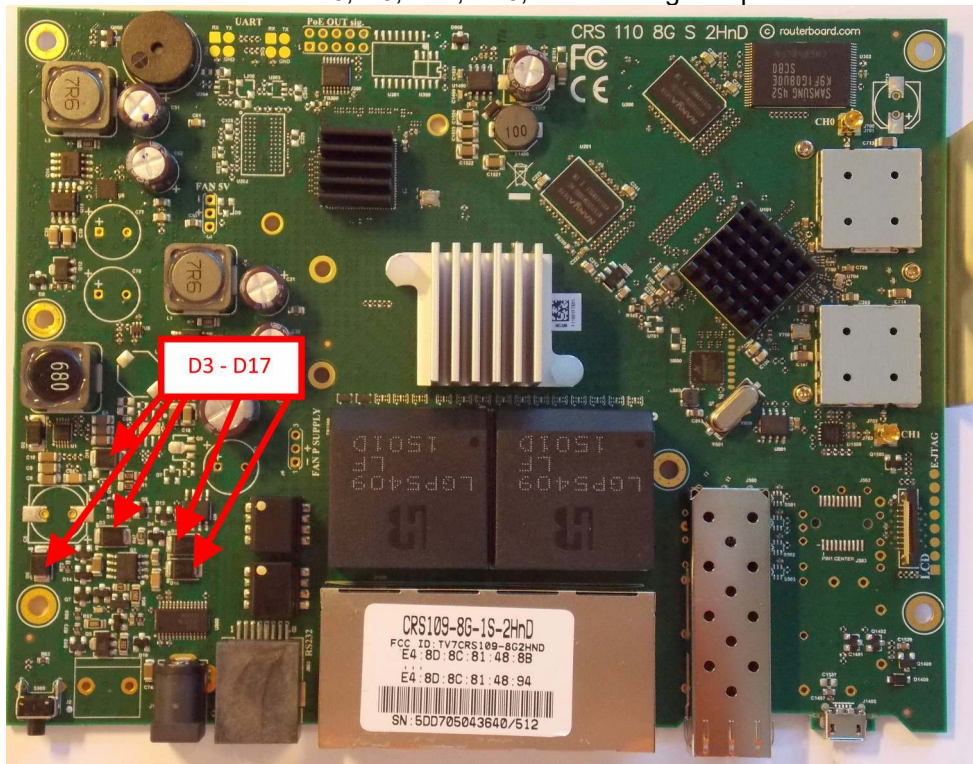

Voltage drop between diode array pin#1 and Ground.

Check voltage drop between TR1200 and TR1201 Ethernet Transformers on ports Ether1 – Ether8 pins and Ground. Ether Pins are circled red. It should be in the range from 0,32V to 0,438V

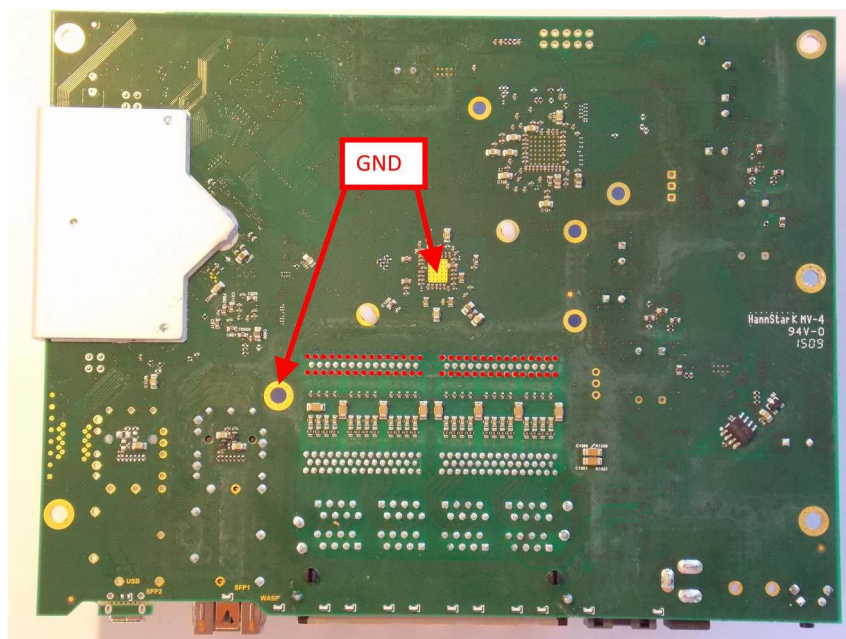

75R termination resistors resistance

Resistors marked with red arrows should be 75Ohm +/- 1%

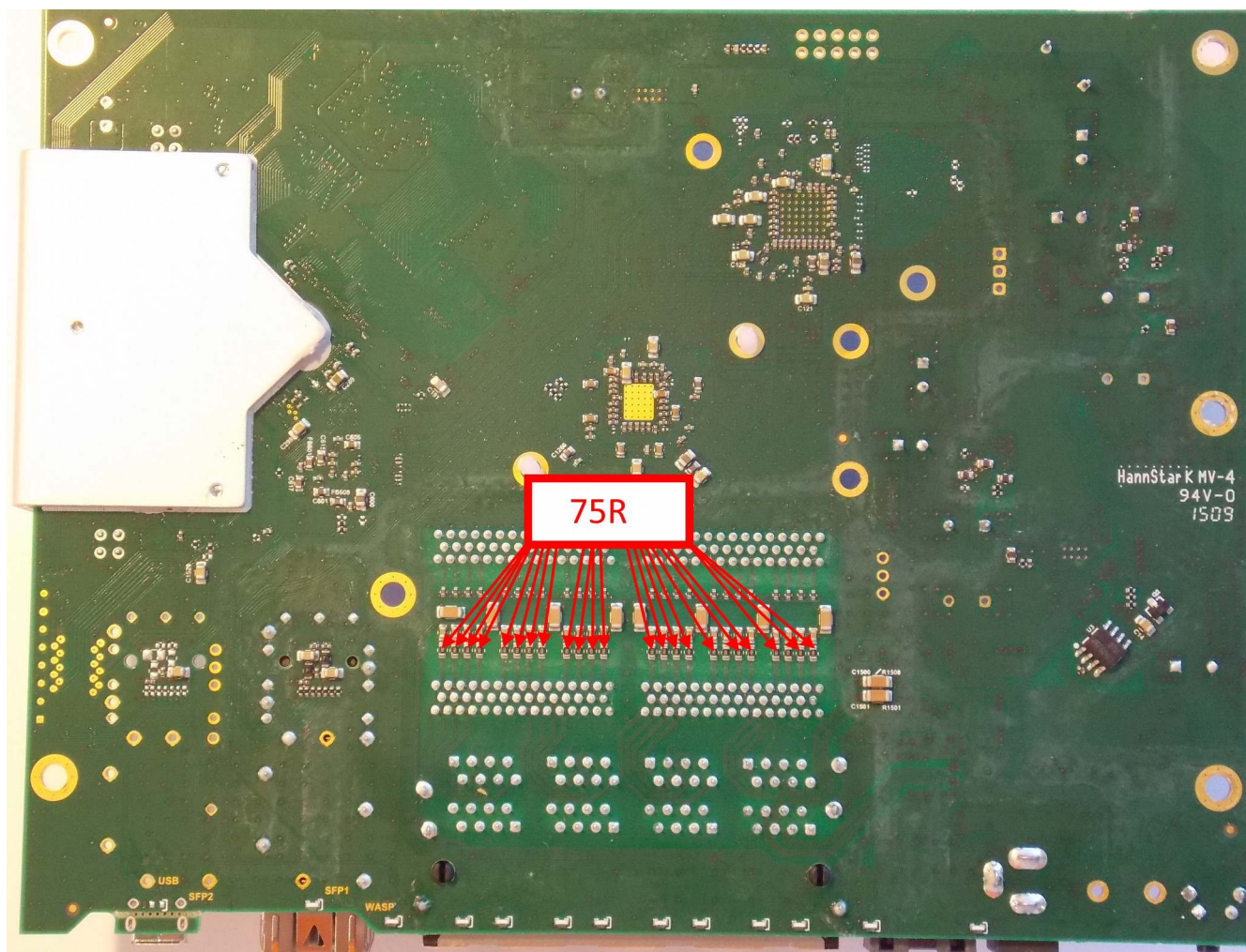

CRS226-24G-2S+ series RouterBoards

CRS226-24G-2S+IN

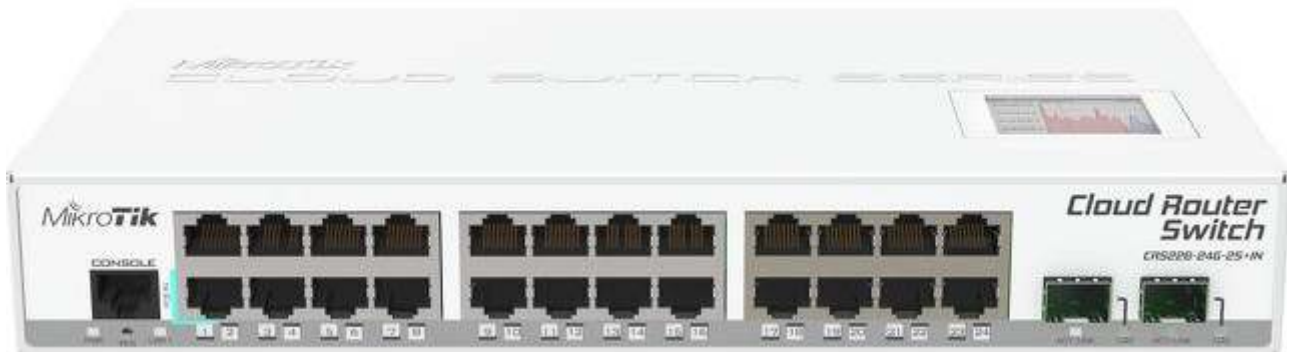

CRS226-24G-2S+RM



Disassembling information

1. Step: use PH2 screw driver to loose backside screws, take off cover.

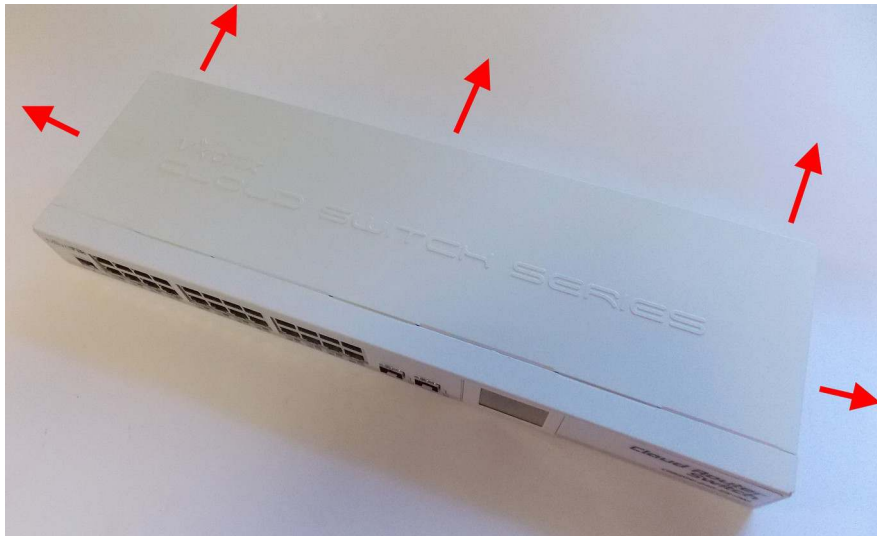

2. step: take off cover carefully, pay a tension to LCD connector. Push up both side of LCD connector from slot with "-" screwdriver as shown in next pictures

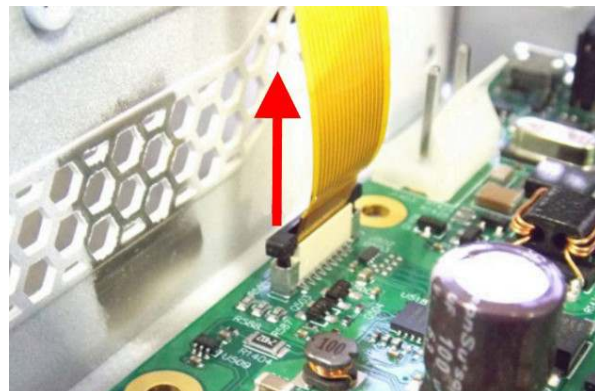

3. Step: use "+" screw driver to loose 7 pcs PCB screws, than take off PCB from case.

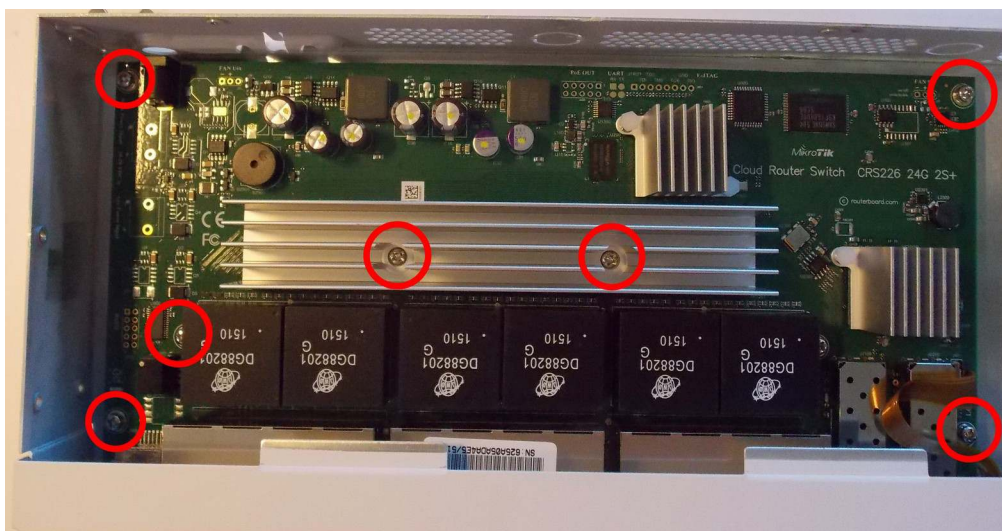

Schottky diode measuring with multimeter in diode mode

Schottky diode reference numbers are D1, D4, D5. Voltage drop value should be about 0,215V

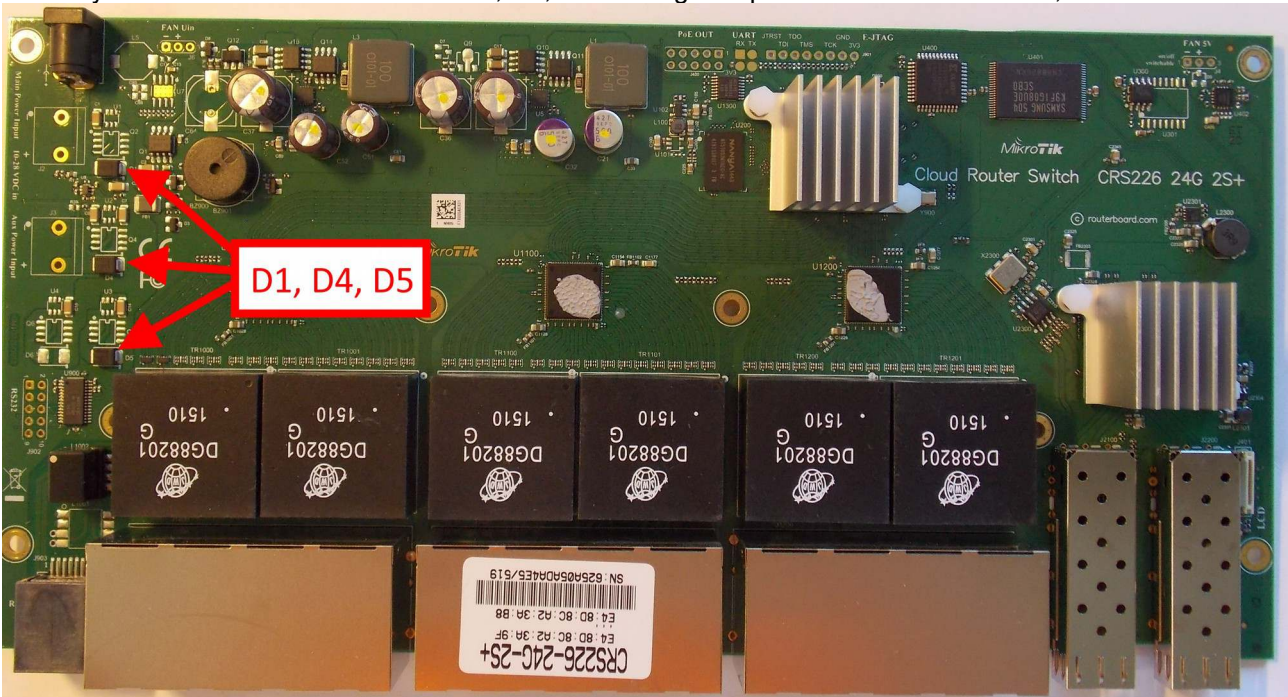

Voltage drop between diode array pin#1 and Ground.

Check voltage drop between TR1200 and TR1201 Ethernet Transformers on ports Ether1 – Ether8 pins and Ground. Ether Pins are circled red. It should be in the range from 0,32V to 0,438V

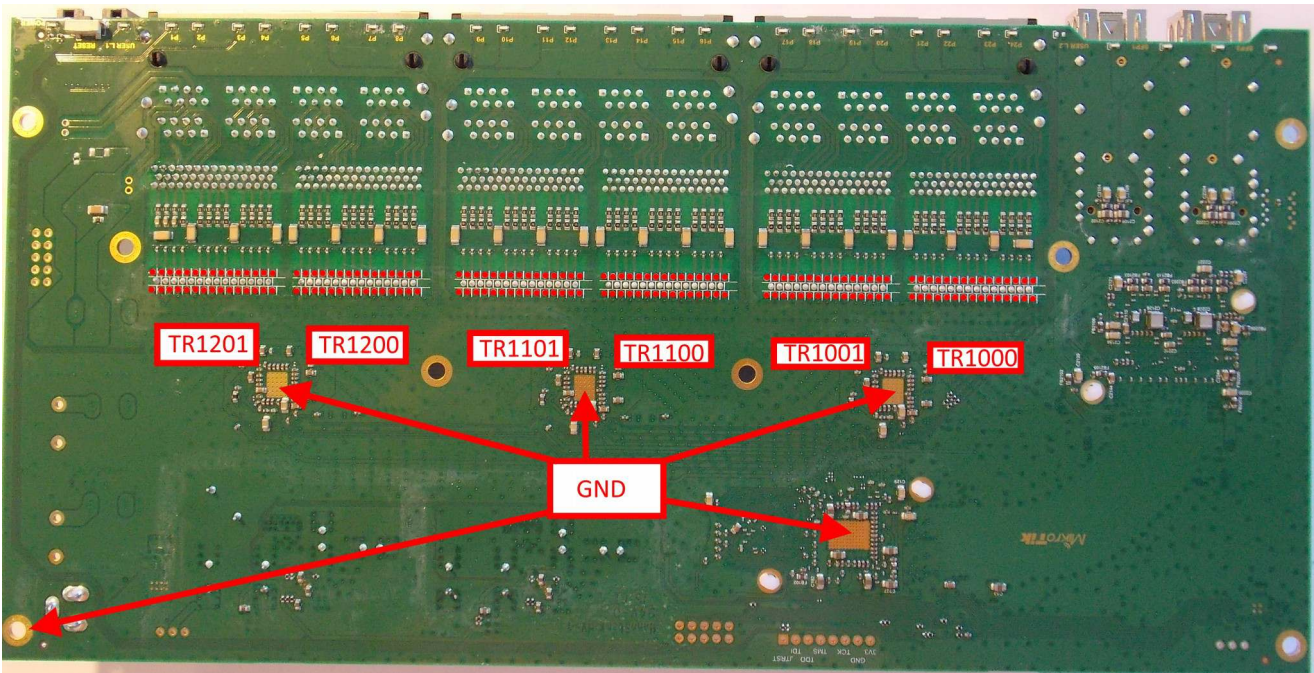

75R termination resistors resistance

Resistors marked with red arrows should be 75Ohm +/- 1%

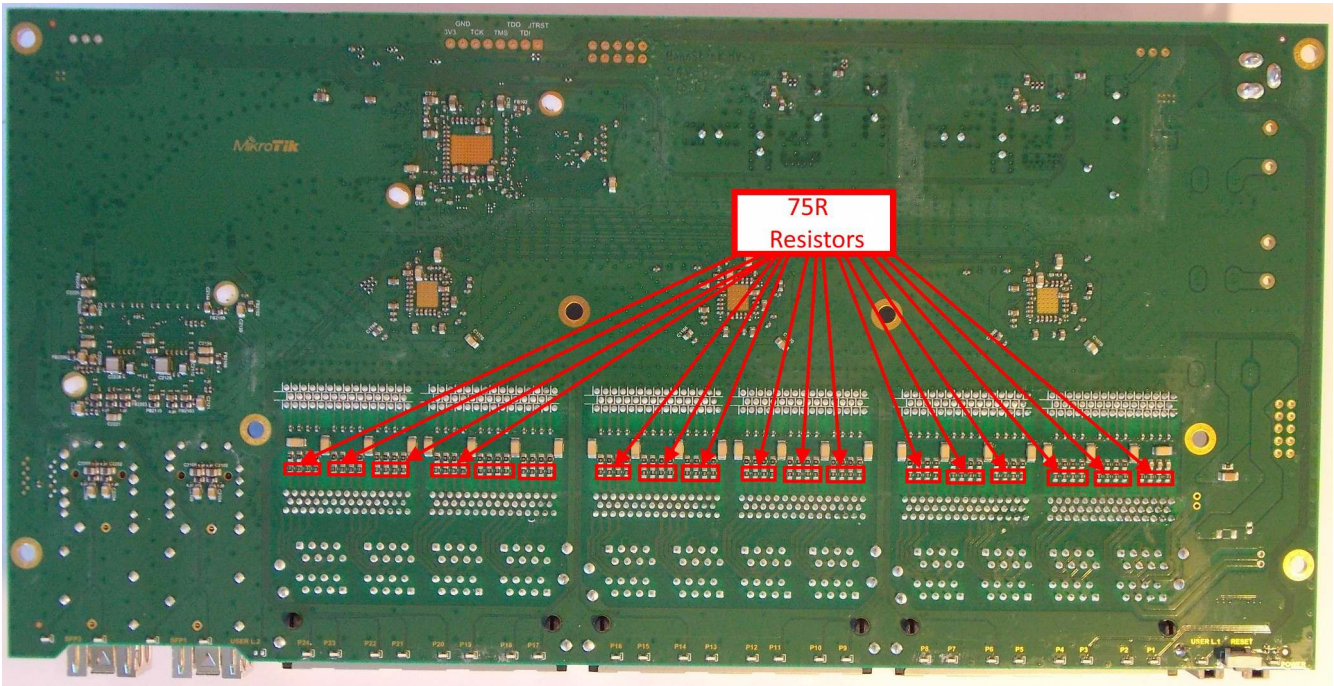

CRS125-24G-1S series

List of Cloud Router Switch CRS125-24G-1S series:

CRS125-24G-1S-IN



CRS125-24G-1S-RM

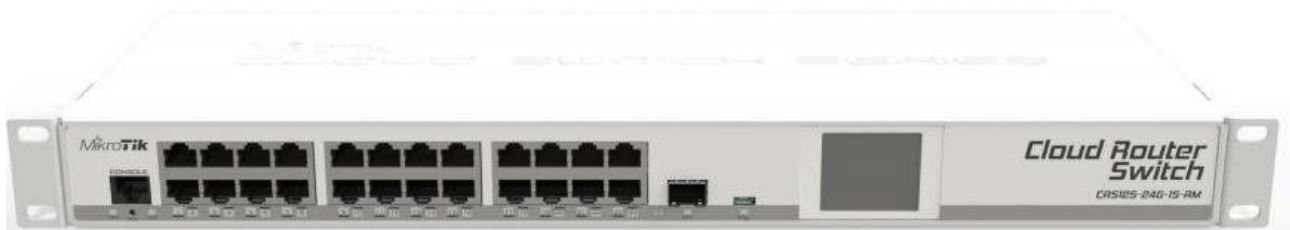

CRS125-24G-1S-2HnD-IN

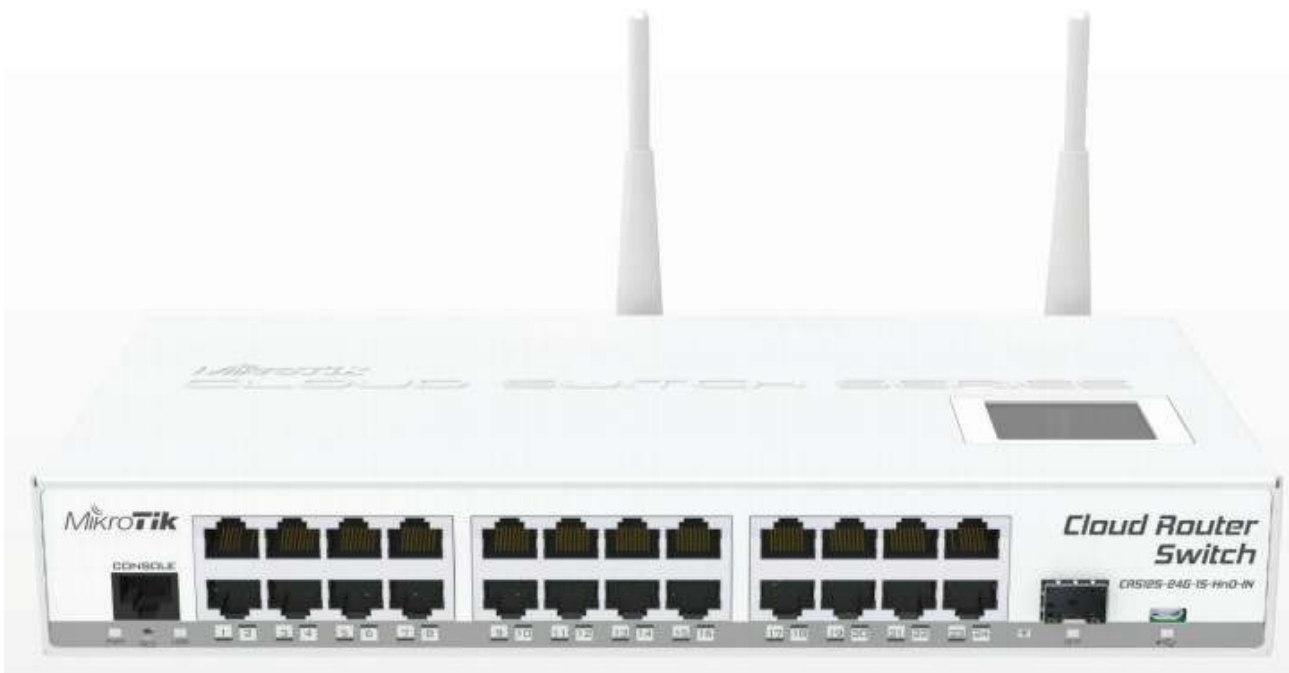

Disassembling information



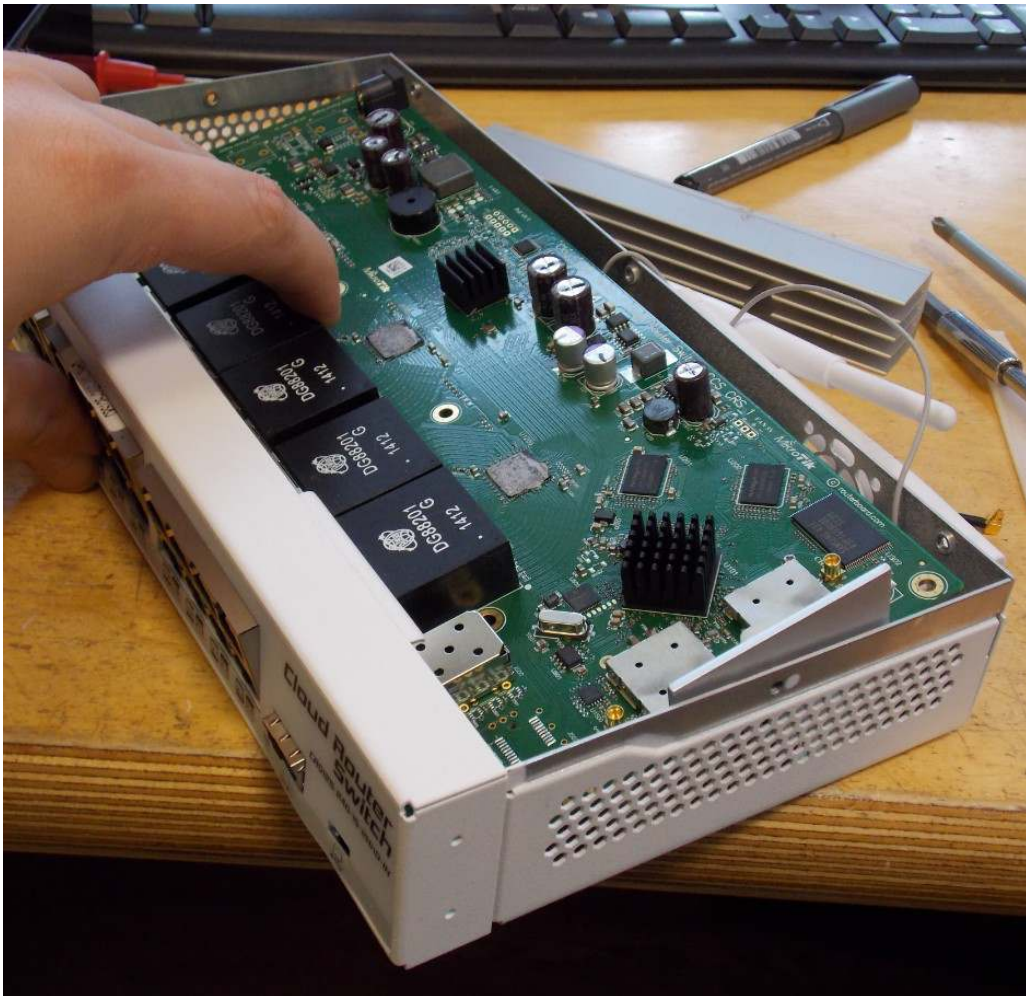
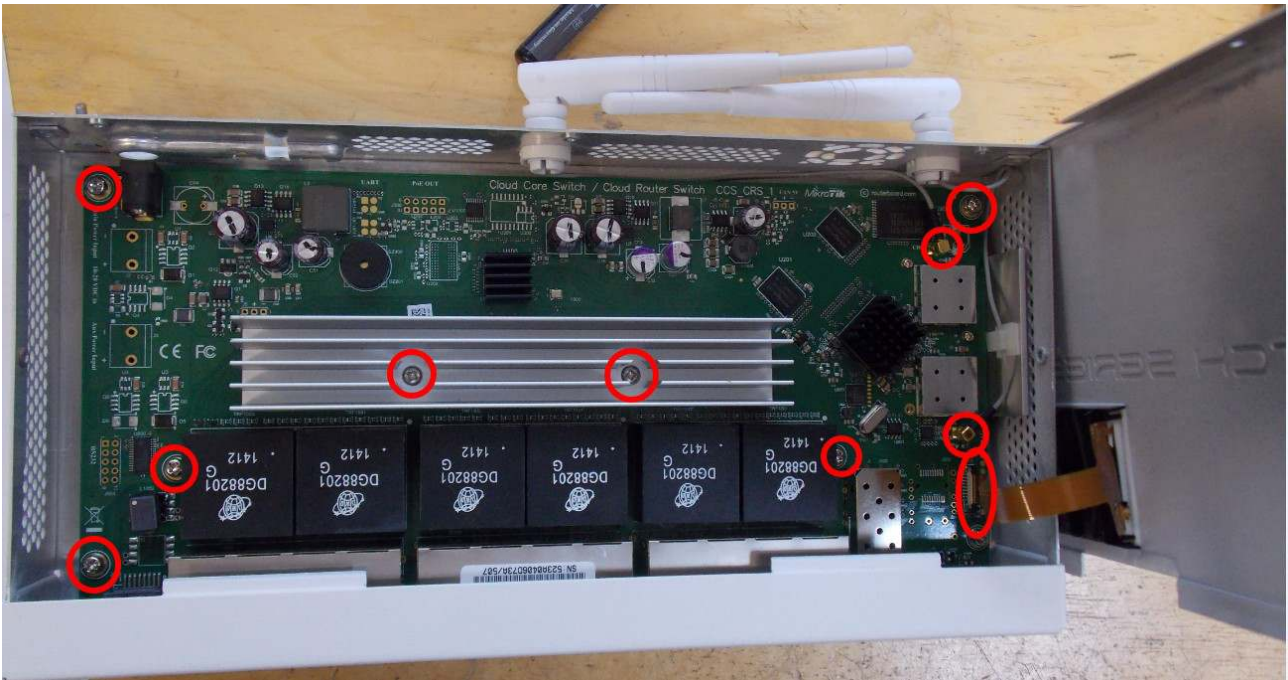

Schottky diode measuring with multimeter in diode mode

Schottky diode reference numbers is D1 and D5; Voltage drop value should be about 0,208V

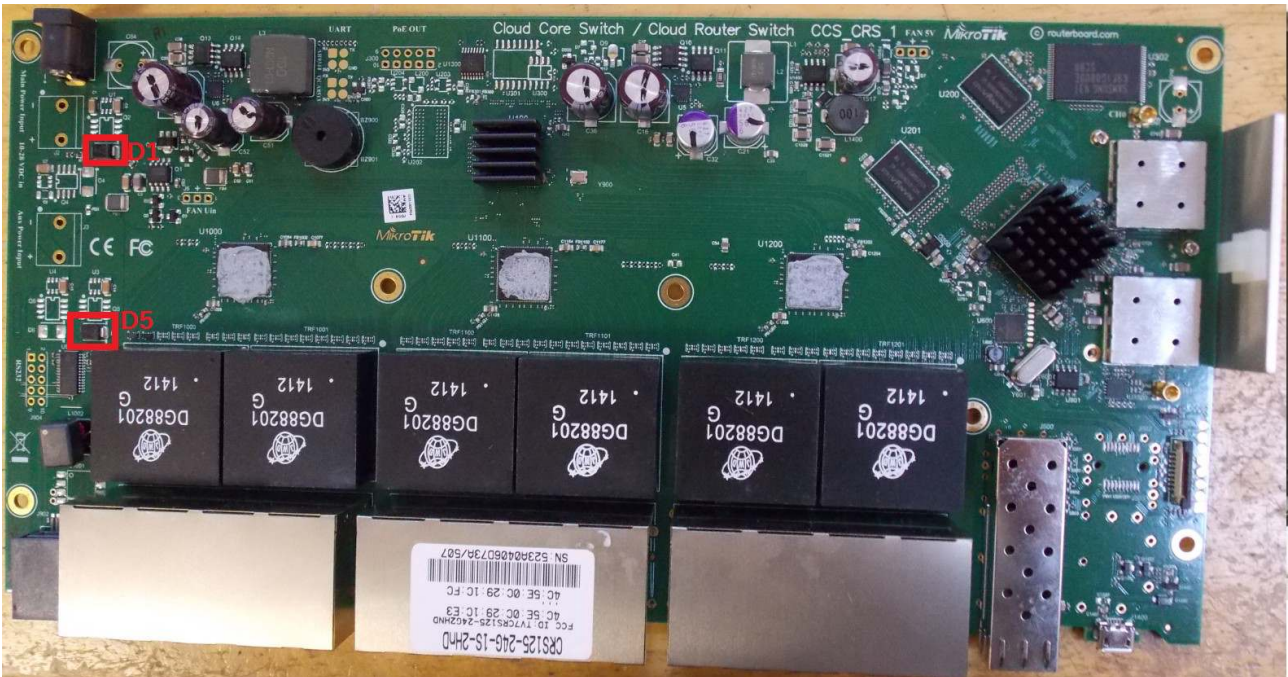

Voltage drop between diode array pin#1 and Ground.

Check voltage drop between Transformer TRF1000, TRF1001, TRF1100, TRF1101, TRF1200 and TR1201 pins and Ground.

It should be in the range from 0,32V to 0,438V

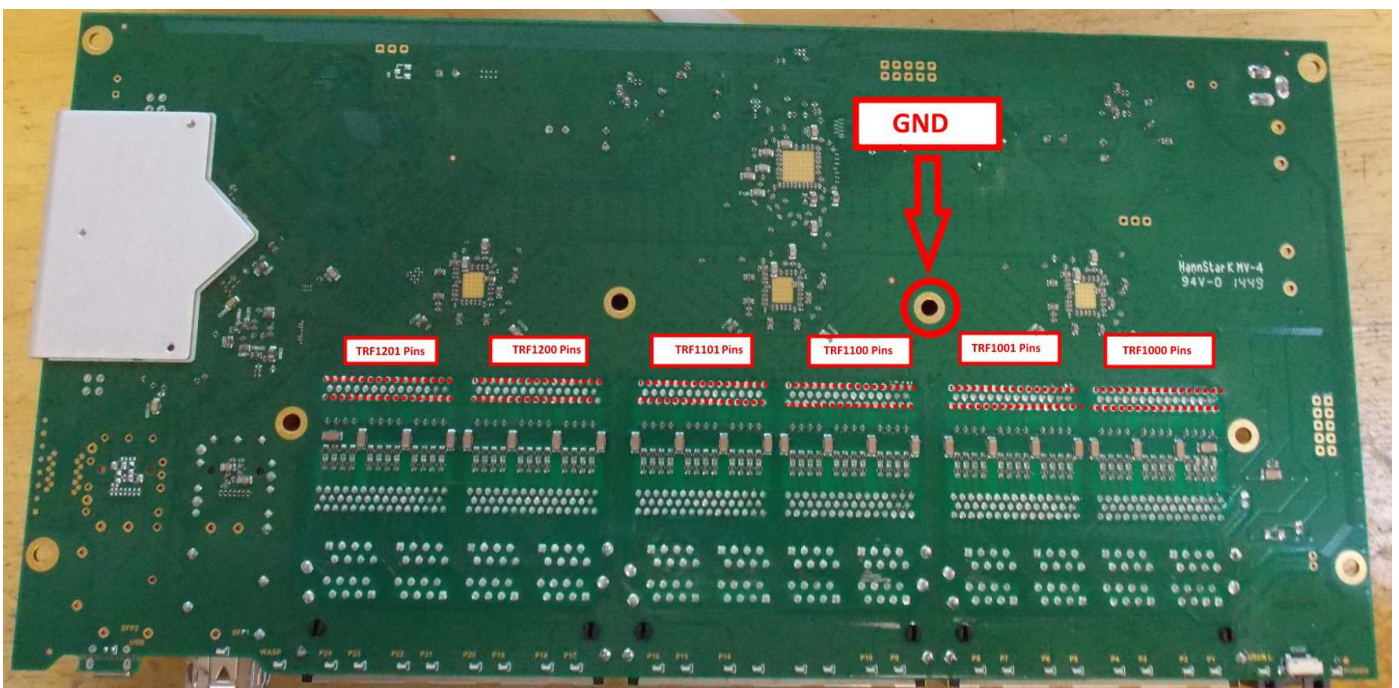

Termination resistors resistance in RJ-45 connector

Red circled resistors resistance should be 750hm +/- 1%

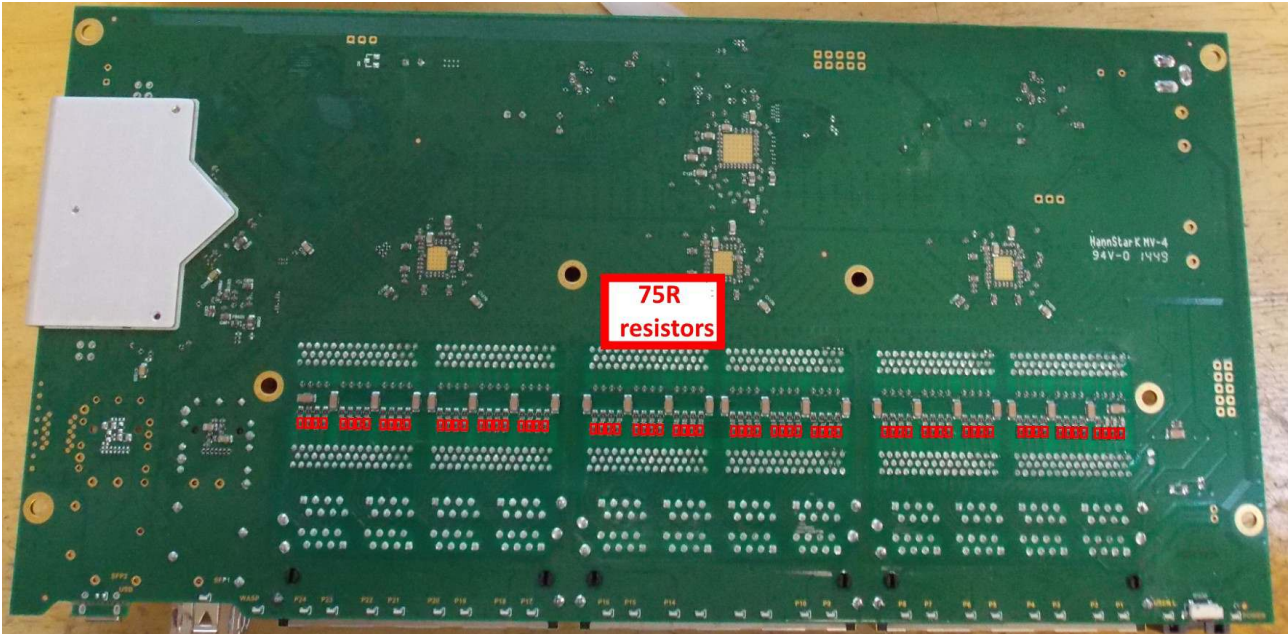

On ports Ether2 – Ether24 You can take patch cord and plug it into the routerboard, and then measure resistance of termination resistors.

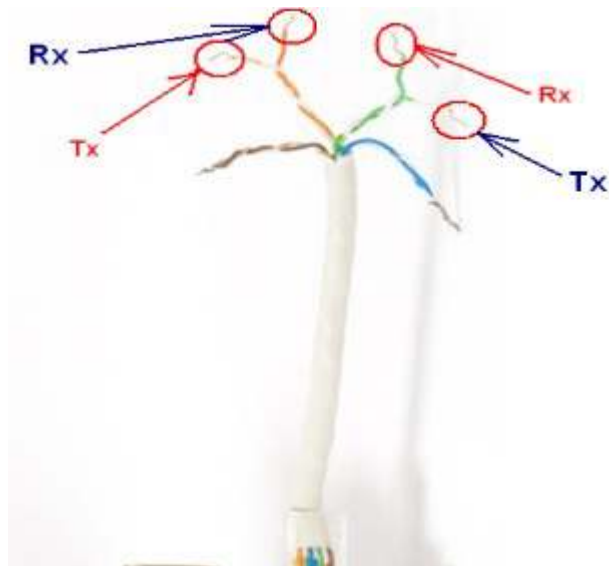

Resistance value between Rx and Tx line must be 150 Ohm +/-4%.

If resistance value is smaller or higher then Tx/Rx line was damaged by high voltage surge.